

Sports Exhaust system - Silver (OP8)/Black (OP9)

Revision: This bulletin replaces bulletin Group 2, 20/19, dated June 5, 2020

Model Year: **As of 2019**

Vehicle Type: **Cayenne (9YA)** including Coupé variant

Engine Type: **DCB/DCBE** = V6/3.0 liter/250 kW (340 hp) = Cayenne

Restrictions: **ONLY** approved for vehicles FROM a certain production date (week/year) (depending on exhaust variant (WITHOUT Petrol Particulate Filter (PPF) and body shape):

- Vehicles **WITHOUT** PPF: from 34 / 2018
- Coupé vehicles: from 09 / 2019

Information: **Retrofitting**

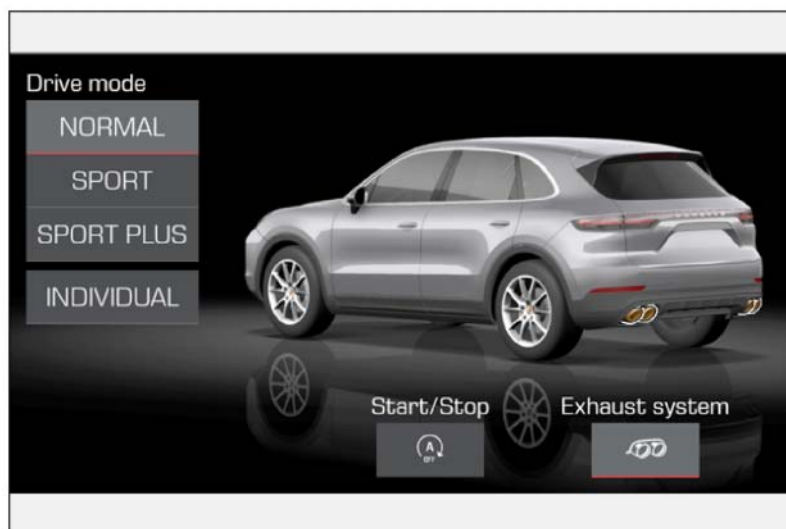

Figure 1

Notes: With the sports exhaust system, the signal for activating the flaps in the rear silencers comes from the respective current map in the DME control unit. The driving status and accelerator pedal position, for example, are decisive factors.

The sports exhaust system can be switched on and off separately using the Porsche Communication Management system (PCM ⇒ *Figure 1*). To do this, select the menu "Car", then "Drive" and then "Exhaust system".

The sports exhaust system is also active in the "SPORT" or "SPORT PLUS" driving modes.

The engine power and exhaust behaviour of the vehicle are not affected.

The sports exhaust system is also available straight from the factory for new vehicles by requesting optional equipment "OP8 – Sports exhaust system (Brushed stainless steel tailpipe)" or "OP9 – Sports exhaust system (Black chrome-plated look tailpipe)".

Parts Info:

ONLY for vehicles WITHOUT Petrol Particulate Filter (PPF):

9Y0.044.222

⇒ Sports exhaust system – Tailpipe in Silver chrome-plated look, set

9Y0.044.222.A

⇒ Sports exhaust system – Tailpipe in Black chrome-plated look, set

Parts List:

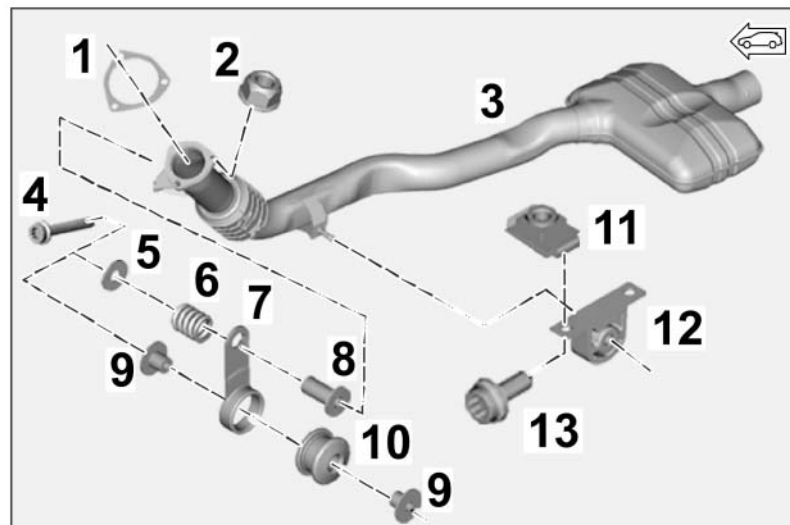

Figure 2

Scope of exhaust system – exhaust pipe area with front silencer (⇒ *Figure 2* = vehicle WITHOUT PPF):

PAB. 253.115.20	1 x	Seal (exhaust pipe with front silencer/manifold) ⇒ <i>Figure 2-1-</i>
N .911.308.02	3 x	Hexagon collar nut, M8, self-locking (flange manifold) ⇒ <i>Figure 2-2-</i>
9Y0.253.301 ¹	1 x	Assembly (ASSY) exhaust pipe with front silencer (VSD, – PPF) ⇒ <i>Figure 2-3-</i>
N .106.720.01	2 x	Cheese head bolt with multiple-tooth internal M8 x 50 (tab on exhaust pipe/transmission) ⇒ <i>Figure 2-4-</i>
PAF.011.670.26	1 x	Washers, 8.4 x 24 x 2 (tab on exhaust pipe) ⇒ <i>Figure 2-5-</i>

PAB.253.353.00	1 x	Pressure spring (tab) ⇒ <i>Figure 2-6-</i>
PAC.253.295	1 x	Tab AL552 ⇒ <i>Figure 2-7-</i>
PAB.253.295	1 x	Tab AL552 (not shown)
PAB.253.205.00	1 x	Spacer tube, Ø 24 x 32 (upper tab) ⇒ <i>Figure 2-8-</i>
PAB.253.205	2 x	Spacer tube, Ø 30 x 16 (lower tab) ⇒ <i>Figure 2-9-</i>
PAB.253.149	1 x	Rubber bush, Ø 42 x 29 (lower tab) ⇒ <i>Figure 2-10-</i>
4H0.821.213	2 x	Speed nut 28 x 18 x 11 ⇒ <i>Figure 2-11-</i>
PAB.253.099.00	1 x	Exhaust pipe holder ⇒ <i>Figure 2-12-</i>
N .107.367.01	2 x	Cylinder collar screw with multiple-tooth socket M8 x 20 (exhaust pipe holder) ⇒ <i>Figure 2-13-</i>
N .105.184.05	1 x	Cheese head bolt with multiple-tooth socket head, self-locking (universal joint for steering gear)

¹ **ONLY** contained in set for vehicles WITHOUT PPF (9Y0.044.222/9Y0.044.222.A!)

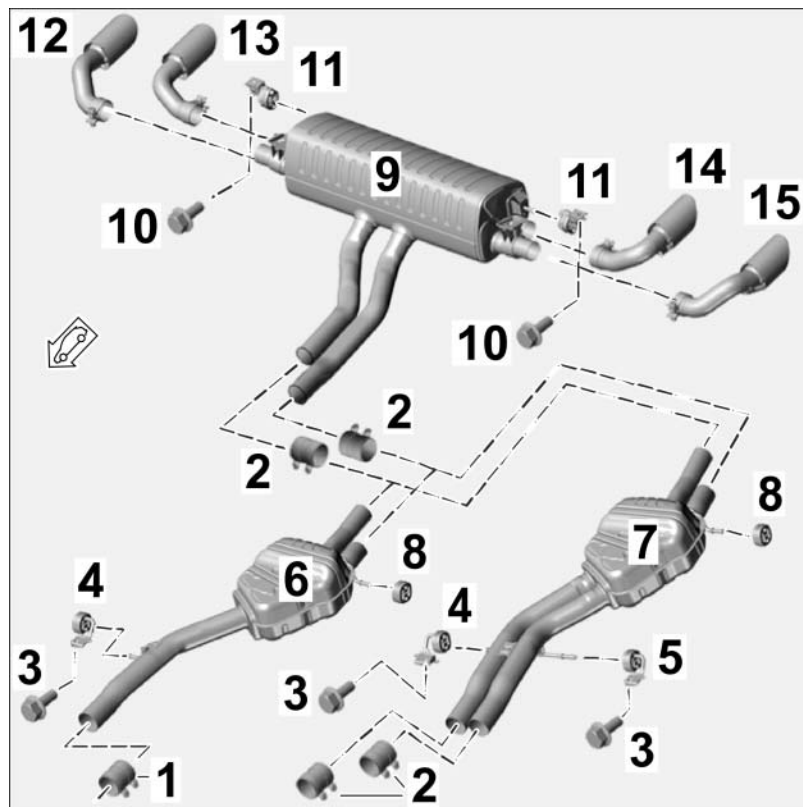

Figure 3

Scope of exhaust system – center, rear silencer and sports tailpipes area (⇒ *Figure 3*):

PAB.253.141.20 ¹	1 x	Clamping sleeve, Ø 75 x 88 ⇒ <i>Figure 3-1-</i>
958.111.220.10	2 x	Clamping sleeve, Ø 65 x 88 ⇒ <i>Figure 3-2-</i>

N .106.978.01	1 x	Hexagon flange bolt, M10 x 30 ⇒ <i>Figure 3-3-</i>
PAB.253.144.01	1 x	Holder for center silencer, front right ⇒ <i>Figure 3-4-</i>
PAB.253.144.10	1 x	Holder for center silencer, front, left ⇒ <i>Figure 3-5-</i>
PAB.253.409 ¹	1 x	Center silencer assembly (MSD, -PPF) ⇒ <i>Figure 3-6-</i>
PAB.253.147.00	1 x	Holder for center silencer, rear left ⇒ <i>Figure 3-8-</i>
9Y0.253.125.A	1 x	Rear silencer assembly ⇒ <i>Figure 3-9-:</i>
N .106.421.01	2 x	Hexagon flange bolt, M8 x 25 ⇒ <i>Figure 3-10-</i>
PAB.253.144.03	2 x	Holder for rear silencer ⇒ <i>Figure 3-11-</i>
N .038.549.4	8 x	Expansion rivet, A8 x 12 (air guide for tunnel, underbody panelling, not shown)
9Y0.253.824.BP ²	1 x	Sports tailpipe, silver chrome-plated, outer right ⇒ <i>Figure 3-12-</i>
9Y0.253.824.BN ²	1 x	Sports tailpipe, silver chrome-plated, inner right ⇒ <i>Figure 3-13-</i>
9Y0.253.823.BN ²	1 x	Sports tailpipe, silver chrome-plated, inner left ⇒ <i>Figure 3-14-</i>
9Y0.253.823.BP ²	1 x	Sports tailpipe, silver chrome-plated, outer left ⇒ <i>Figure 3-15-</i>
9Y0.253.824.BS ²	1 x	Sports tailpipe, black chrome-plated, outer right (not shown)
9Y0.253.824.BR ²	1 x	Sports tailpipe, black chrome-plated, inner right (not shown)
9Y0.253.823.BR ²	1 x	Sports tailpipe, black chrome-plated, inner left (not shown)
9Y0.253.823.BS ²	1 x	Sports tailpipe, black chrome-plated, outer left (not shown)

² **ONLY** contained in respective set!



Figure 4

Scope of electrics – engine noise area (⇒ Figure 4):

9Y0.907.159.AL	1 x	Engine noise control unit ⇒ Figure 4 -1-
PAB.907.249.00	1 x	Engine noise control unit holder ⇒ Figure 4 -2-
4H0.907.601.D	1 x	Engine noise pulse sender ⇒ Figure 4 -3-
N .908.877.03	1 x	M6 hexagon nut, self-locking ⇒ Figure 4 -4-
9Y0.044.210	1 x	Wire harness assembly for engine noise ⇒ Figure 4 -5-
— — — ³	1 x	Base cable ties (CL 611) ⇒ Figure 4 -6-
— — — ³	1 x	Cable holder (white) ⇒ Figure 4 -7-
— — — ³	1 x	Base cable ties, externally toothed (CL 614) ⇒ Figure 4 -8-
— — — ³	1 x	Connector housing (4-pin) ⇒ Figure 4 -9-
— — — ³	2 x	7,5 A fuse (not shown)

³ Contained in the "wire harness assembly for engine noise (9Y0.044.210)" set!



Figure 5

Scope of electrical system – exhaust flaps and interior mechanism area (⇒ Figure 5):

9Y0.044.210.A	1 x	Wire harness assembly for exhaust flaps ⇒ Figure 5-1-
— — — — 4	1 x	Grommet (internal Ø 66.5 – left side) ⇒ Figure 5-2-
— — — — 4	1 x	Grommet (internal Ø 46 – right side) ⇒ Figure 5-3-
— — — — 4	1 x	Corrugated hose, 4.5 x 7.6 x 220 ⇒ Figure 5-4-
— — — — 4	1 x	Corrugated hose, 4.5 x 7.6 x 230 (not shown)
— — — — 4	2 x	Plug socket (4-pin) ⇒ Figure 5-5-
— — — — 4	2 x	15 A fuse (not shown)
N .020.902.2	20 x	Tie-wrap, 3.6 x 246 (not shown)
999.513.052.40	10 x	Tie-wrap, 4.8 x 188 (not shown)
PAB.886.373	5 x	Fixing clip for seat cushion ⇒ Figure 5-6-
N .912.052.01	8 x	Cheese head bolt with multiple-tooth internal M10 x 35 (front and rear seat) ⇒ Figure 5-7-
PAF.912.664	4 x	Hexagon flange bolt, M12 x 1.5 x 40 (rear seat) ⇒ Figure 5-8-

4 Contained in the "Wire harness assembly for exhaust flaps (9Y0.044.210.A)" set!

**Information**

ONLY in the event of repairs/replacement:

Items **WITHOUT** a part number in the parts list can be found/ordered from the Porsche Electronic Parts Catalog = PET.

Check model year and vehicle equipment (I-no.) in the standard catalog!

Materials:	000.043.172.00	1 x	Sealing cord
	— — —	1 x	Commercially available rust solvent, e.g. WD40
	— — —	1 x	Wrapping/insulating tape (commercially available)
	— — —	1 x	Auxiliary line (Tekalan or Teflon hose) approx. 1,500 mm/ 59 in long

Tools:	Pole terminal puller	Nr.90 Pos.3 - Torque wrench
	9900 - PIWIS Tester 3	Transmission and Engine Jack
	Restraining strap for securing loads	Flashlight
	Nr.89 Pos.5 - Torque screwdriver	
	Three-mandrel pliers for hoses and sleeves (commercially available)	

- Installing:
- 1 Preparatory work
 - 1.1 Drive the vehicle onto a lifting platform. ⇒ *Workshop Manual '4X00IN Lifting the vehicle'*
 - 1.2 Connect battery charger. ⇒ *Workshop Manual '2X00IN Trickle charging 12-volt lithium-ion battery'*
 - 1.3 Exposing the plenum panel/engine compartment area
 - 1.3.1 Remove moulding for windscreen. ⇒ *Workshop Manual '666119 Removing and installing moulding for windscreen'*
 - 1.3.2 Remove wiper arms. ⇒ *Workshop Manual '922519 Removing and installing wiper arm'*
 - 1.3.3 Remove front lid seal. ⇒ *Workshop Manual '553319 Removing and installing front lid seal'*
 - 1.3.4 Remove cowl panel cover. ⇒ *Workshop Manual '508719 Removing and installing cowl panel cover'*

- 1.3.5 Remove filler neck from reservoir for windshield washer system (⇒ *Figure 9-1-*). ⇒ *Workshop Manual '926019 Removing and installing windscreen-washer reservoir'*

- 1 – Filler neck for windscreen-washer reservoir
- 2 – Engine cover (design cover)
- 3 – Strut brace (installation position of engine sound control unit)

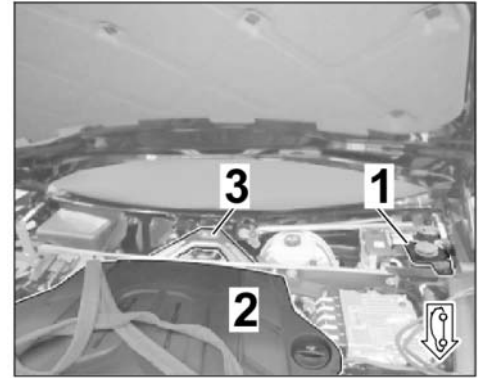

Figure 9

- 1.3.6 Remove engine cover (design cover) (V6 Turbo, ⇒ *Figure 9-2-*). ⇒ *Workshop Manual '108319 Removing and installing engine cover (design cover) (V6 Turbo)'*
- 1.3.7 Remove air cleaner housing. ⇒ *Workshop Manual '242519 Removing and installing air cleaner housing'*
- 1.4 Removing the seats
- 1.4.1 Remove the luggage compartment cover in the boot.
- 1.4.2 Remove padding for rear seat surface (2/3-split folding rear seat). ⇒ *Workshop Manual '74491901 Removing and installing padding for rear seat surface (2/3-split folding rear seat)'*



CAUTION

Heavy components

- Risk of pinching
- ⇒ Wear personal protective gear.
- ⇒ Get someone to help if necessary.

- 1.4.3 Loosen 2/3-split folding rear seat. ⇒ *Workshop Manual '724819 Removing and installing rear seat'*



Information

The help of another person is required for this step.

- 1.4.4 Carefully lift the 2/3-split folding rear seat out of the vehicle via the boot.

⚠ CAUTION

Heavy components

- Risk of pinching
- ⇒ Wear personal protective gear.
- ⇒ Get someone to help if necessary.

1.4.5 Loosen front seat (left). ⇒ *Workshop Manual '720119 Removing and installing front seat'*



Information

The help of another person is required for this step.

1.4.6 Carefully lift the front seat (left) from the vehicle to the rear via the boot.

1.5 Expose the A-pillar area (left side) (⇒ *Figure 10*)

- 1 – Front side-section trim panel
- 2 – Footrest
- 3 – Inner door sill trim (front)
- 4 – A-pillar trim panel (lower part)
- 5 – 1/3 rear seat

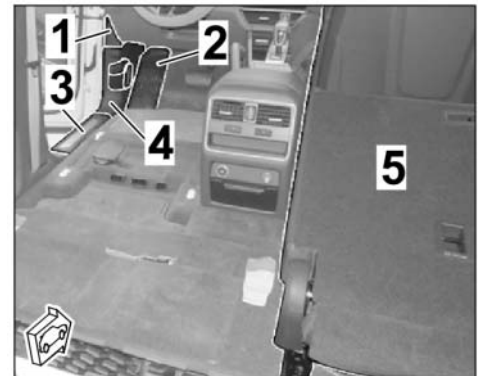

Figure 10

1.5.1 Remove front side-section trim panel. ⇒ *Workshop Manual '702419 Removing and installing front side-section trim panel'*

1.5.2 Remove footrest. ⇒ *Workshop Manual '703519 Removing and installing footrest'*

1.5.3 Remove A-pillar trim panel (lower part). ⇒ *Workshop Manual '70571901 Removing and installing A-pillar trim panel (lower part)'*

1.6 Expose the B-pillar area (left side) (⇒ *Figure 11*)

- 1 – B-pillar trim panel (upper part)
- 2 – B-pillar trim panel (lower part)
- 3 – (Inner) door sill trim
- 4 – C-pillar trim panel (lower part)
- 5 – Side trim panel of the boot (left side)
- 6 – Bulkhead cover

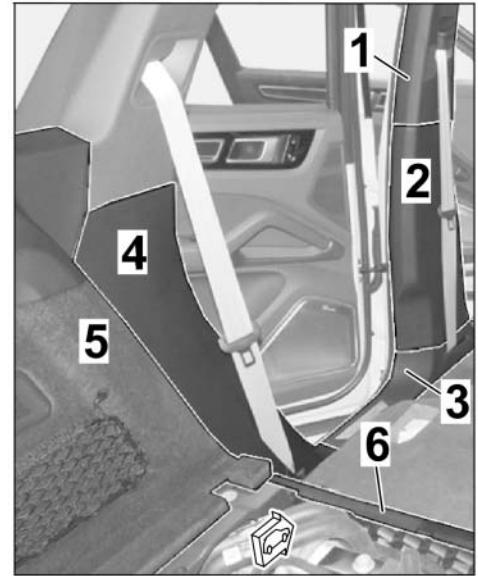

Figure 11

1.6.1 Loosen B-pillar trim panel (upper part) and leave it hanging on the belt strap. ⇒ *Workshop Manual '70671901 Removing and installing B-pillar trim panel (upper part)'*

1.6.2 Remove inner door sill trim. ⇒ *Workshop Manual '680519 Removing and installing inner door sill trim'*

1.6.3 Remove B-pillar trim panel (lower part). ⇒ *Workshop Manual '70671903 Removing and installing B-pillar trim panel (lower part)'*

1.7 Expose C-pillar/luggage compartment area

1.7.1 Remove (rear) lock carrier cover. ⇒ *Workshop Manual '703919 Removing and installing cover for front lock support'*

1.7.2 Remove side trim panel boot light (left / right). ⇒ *Workshop Manual '964019 Removing and installing luggage compartment light in side trim panel'*

1.7.3 Remove side trim panel for boot (left / right). ⇒ *Workshop Manual '700319 Removing and installing side trim panel for rear luggage compartment'*

1.7.4 Remove C-pillar trim panel (lower part) on left side. ⇒ *Workshop Manual '70681901 Removing and installing C-pillar trim panel (lower part)'*

1.7.5 Push the 1/3 rear seat forward and remove the cover on the bulkhead.

CAUTION

Hot components

- Risk of burns
- ⇒ Let hot components cool down.
- ⇒ Wear personal protective gear.

- 1.8 Work in the exhaust system area
- 1 – Cover for rear underbody
 - 2 – Rear tunnel cover
 - 3 – Front underbody cover (rear section)
 - 4 – Tailpipe (left/right)

1.8.1 Remove rear underbody cover and rear tunnel cover (⇒ *Figure 12 -1 and 2-*). ⇒ *Workshop Manual '519419 Removing and installing cover for rear underbody'*

1.8.2 Remove front underbody cover (rear section) (⇒ *Figure 12-3-*). ⇒ *Workshop Manual '519219 Removing and installing cover for front underbody'*

1.8.3 Remove tailpipe (left / right) (⇒ *Figure 12-4-*). ⇒ *Workshop Manual '263419 Removing and installing tailpipe'*

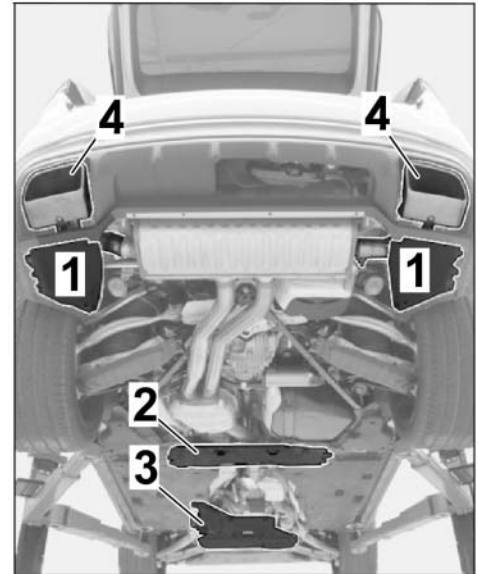

Figure 12

CAUTION

Heavy components

- Risk of pinching
- ⇒ Wear personal protective gear.
- ⇒ Get someone to help if necessary.

1.8.4 Remove exhaust system **WITHOUT** removing the tunnel strut (V6 Monoturbo). ⇒ *Workshop Manual '260119 Removing and installing exhaust system (V6 monoturbo)'*

1.8.5 Remove the catalytic converter:

- Vehicles **WITHOUT** PPF: ⇒ *Workshop Manual '267319 Removing and installing catalytic converter (V6 monoturbo)'*
- Vehicles **WITH** PPF: ⇒ *Workshop Manual '267319 Removing and installing catalytic converter with particle filter (V6 monoturbo)'*

2 Install engine noise control unit and pulse sender

2.1 Installing the engine noise control unit

2.1.1 Check whether there is a tie-wrap on the side tab on the engine noise control unit. Remove the tie-wrap if necessary.

2.1.2 Insert the engine noise control unit at the underside in the control unit holder (⇒ *Figure 13*).

- 1 – Engine noise control unit
- 2 – Control unit holder.
- 3 – Locking/unlocking

2.1.3 Push the engine noise control unit in the holder to the opposite side of the plug connection (⇒ *Figure 13*), until the control unit is engaged in the holder.

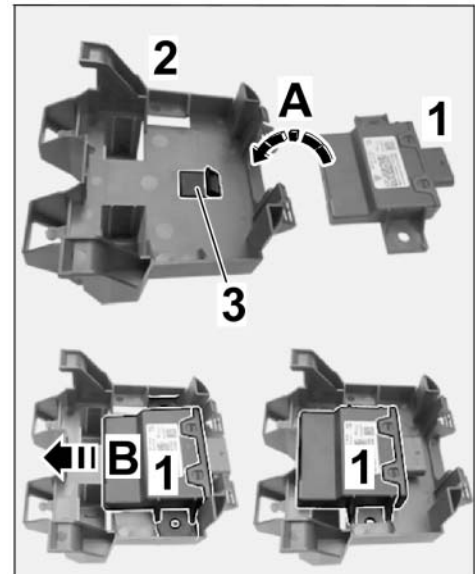

Figure 13

2.1.4 Establish a plug connection from the wire harness for the engine noise control unit (⇒ *Figure 14 -3-*) to the engine noise control unit (6-pin ⇒ *Figure 14-2-*).

- 1 – Control unit holder.
- 2 – Engine noise control unit
- 3 – Wire harness for engine noise
- 4 – Line clip
- 5 – Dome strut
- 6 – Engine noise pulse sender (LHD position)

2.1.5 Install the holder with the engine noise control unit to the strut brace (plenum panel area) (⇒ *Figure 14*).

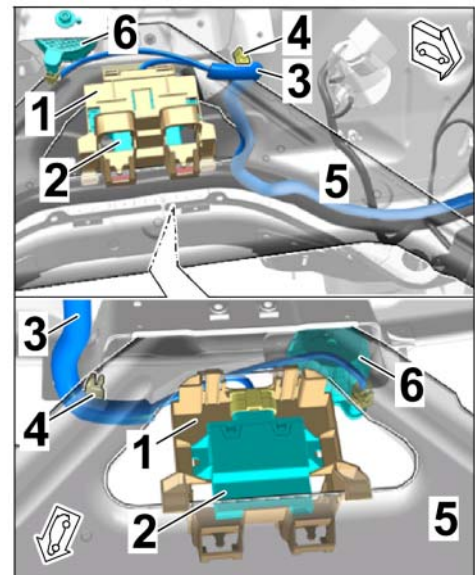

Figure 14



Information

Check that the electric line for the plug connection for the engine noise pulse sender is routed correctly.

- The line must **NOT** be touching the engine noise pulse sender holder (on the body side)!
- Route the line differently if necessary and use a tie-wrap to secure the line to existing lines or holders without tensile stress and so that no chafing or rattling occurs.

2.2 Installing the engine noise pulse sender

- A** – Installation position of the pulse sender – LHD
- B** – Installation position of pulse sender – RHD (not applicable for North America)
- 1** – Engine noise pulse sender
- 2** – Bulkhead holder
- 3** – Wire harness for engine noise
- 4** – Dome strut

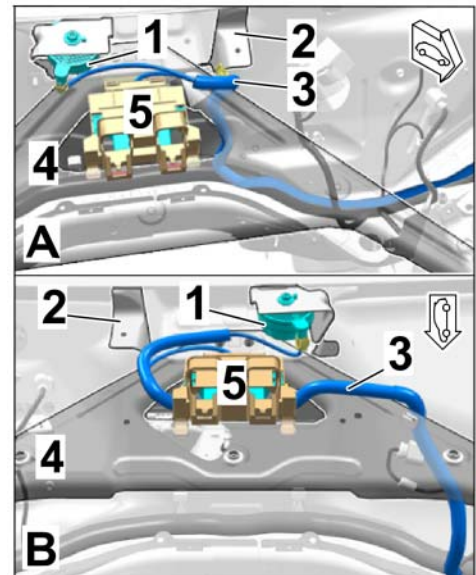

Figure 15

2.2.1 Establish electric plug connections to the engine noise pulse sender (2-pin).

2.2.2 Guide the pin (underside of engine noise pulse sender) into the hole on the bulkhead holder from below (⇒ Figure 15-2-, plenum panel).

2.2.3 Secure the engine noise pulse sender, facing downwards, in the bulkhead holder (plenum panel) using an M6 hexagon nut (1 x) (⇒ Figure 15)

Tightening torque 5 Nm (3.5 ftlb.) +/-0.75 Nm (+/-0.4 ftlb.)

2.3 Lay the electric wire harness for the engine noise to the connection point (preparation)

Connections for the wire harness for the engine noise:

- 1 – Engine noise control unit connector (6-pin)
- 2 – Engine noise pulse sender connector (2-pin)
- 3 – Connection point lines for engine noise
- 4 – Connector housing (4-pin)

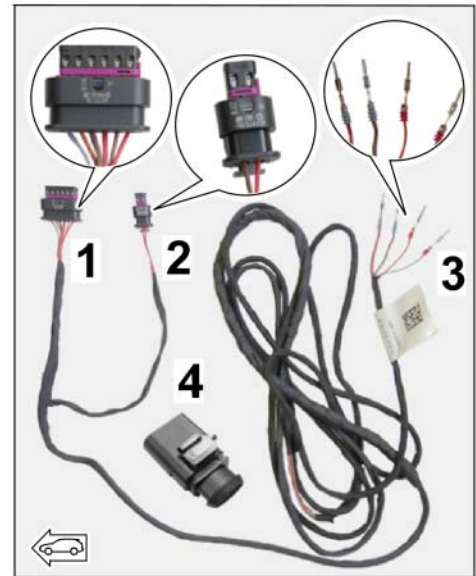

Figure 16

- 2.3.1 Cut off the cone (repair opening) on the grommet on the bulkhead (in the A-pillar plenum panel area – left) (⇒ Figure 17).

- A – RHD vehicle (not applicable for North America)
- B – LHD vehicle
- 1 – Cone (repair opening)
- 2 – Grommet on bulkhead
- 3 – Dome strut

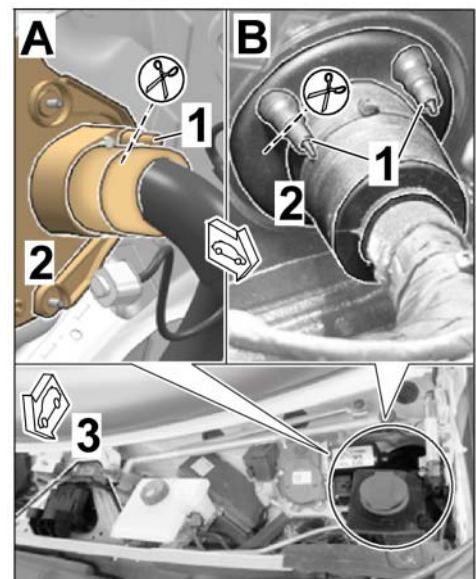

Figure 17

2.3.2 Lay the wire harness for the engine noise to the grommet on the bulkhead (in the A-pillar plenum panel area – left (⇒ Figure 18):

- A – LHD vehicle
- B – RHD vehicle (not applicable for North America)
- 1 – Dome strut
- 2 – Cable clip
- 3 – Grommet on bulkhead
- 4 – Wire harness for engine noise

- Strut brace → cable clip on holder → along wire harness → beneath brake booster → grommet on bulkhead (area of plenum panel A-pillar – left) → passenger compartment

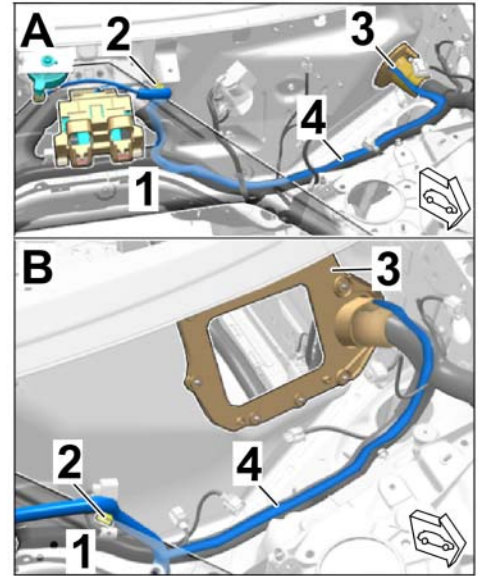

Figure 18

2.3.3 Securing the wire harness for engine noise in the strut brace area

LHD vehicles: Installing the cable clip on the bulkhead holder (⇒ Figure 19)

- 1 – Holder with engine noise control unit
- 2 – Engine noise pulse sender
- 3 – Cable clip
- 4 – Wire harness for engine noise

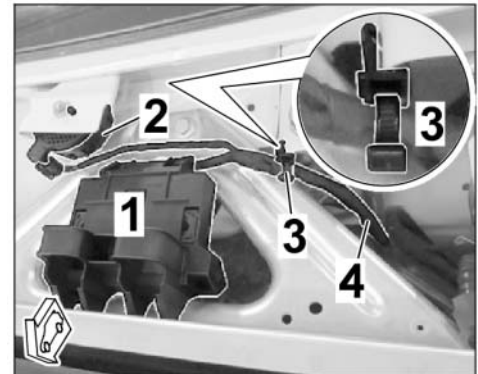

Figure 19

- 2.3.4 Loosen left front floor covering and fold it up as far as possible (⇒ Figure 21). ⇒ *Workshop Manual '704119 Removing and installing front floor covering'*

- 1 – Front floor covering, left
- 2 – Connection point with foam (protection from chafing/movement)

- 2.3.5 Lay the wire harness for engine noise to the connection point (preparation in the floor group area, front seat – left)

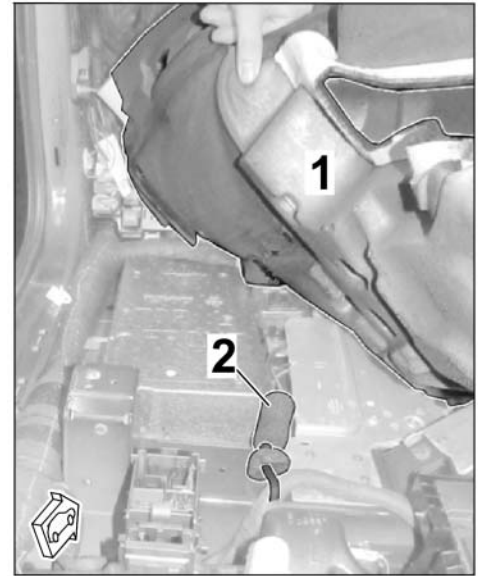

Figure 21

LHD vehicles: (⇒ Figure 22)

- 1 – Grommet on bulkhead
- 2 – Fuses/relays
- 3 – Fuse box
- 4 – Wire harness for engine noise

- Grommet on bulkhead (passenger compartment A-pillar, left) → beneath the fuse box (**DO NOT** remove the fuse box!) → Lower A-pillar (left)

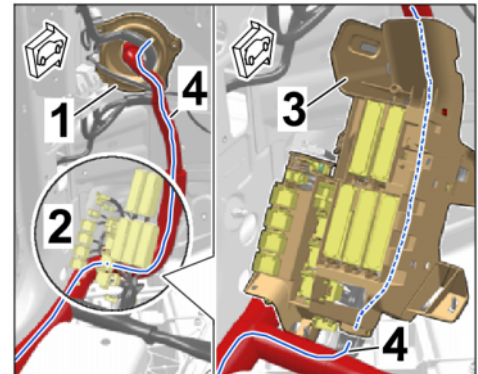

Figure 22

Lower A-pillar (left) → along wire harness for door entry (left) → connection point (preparation) area of front seat, left ⇒ *Figure 24*)

- 1 - Wire harness for engine noise
- 2 - Threaded bush for mounting left front seat
- 3 - Connection point (preparation)

2.4 Connecting the electric wire harness for engine noise at the connection point (preparation)

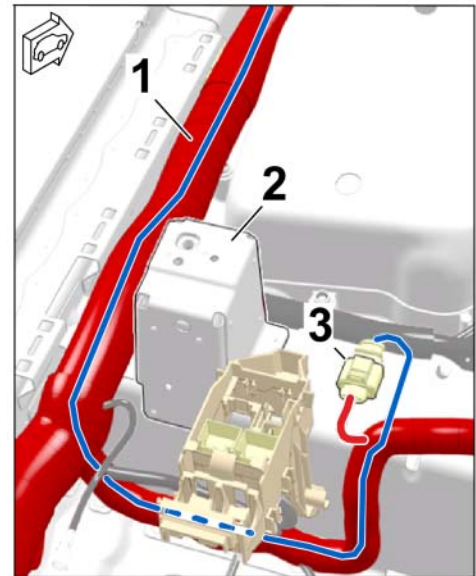

Figure 24

2.4.1 Unlocking the socket housing (4-pin, see parts list) (⇒ *Figure 25*).

- 1 - Fuse
- 2 - Pin connector socket (4-pin)

2.4.2 Connect the lines with pin contact and single-core seal (wire harness for engine noise) in the connector housing (4-pin, see parts list ⇒ *Figure 26 -inset-*) as follows:

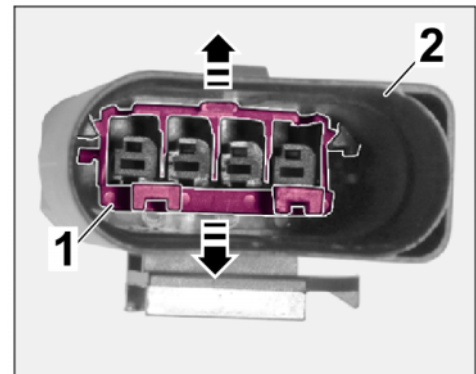

Figure 25

Connector (4-pin)	Line/function
Chamber 1	RT / BN; 0.75 ² = Power supply, fuse box D3
Chamber 2	BN; 0.75 ² = Ground
Chamber 3	OR / BN; 0.35 ² = CAN Bus Extended Low
Chamber 4	GR; 0.35 ² = CAN Bus Extended High

2.4.3 Lock connector housing (4-pin) and establish a plug connection to the connection point (⇒ *Figure 26*).

- 1 – Pin connector socket (4-pin)
- 2 – Plug connection to connection point
- 3 – Foam (protection from chafing/movement)

2.4.4 Re-position the foam (protection from chafing/movement) over the plug connection.

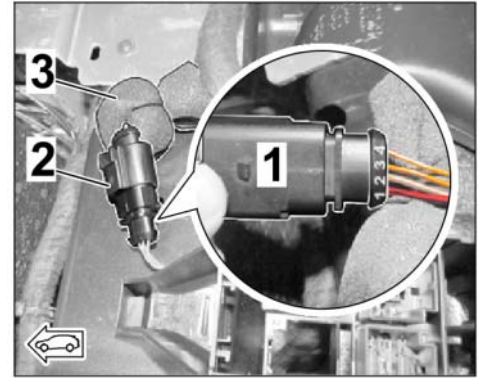

Figure 26

NOTICE

Incorrect line routing

- Risk of damage to lines and hoses
 - Malfunction and fault memory entry on control unit
- ⇒ Avoid small bending radii when routing lines.
- ⇒ File down edges and burrs in the routing area or mask them with adhesive tape.
- ⇒ Maintain a sufficient distance from components exposed to high temperatures while driving.

2.5 Use tie-wraps to secure the motor noise wire harness in the passenger compartment to existing lines/components, avoiding tensile stress so that no chafing occurs.

2.6 Seal the wire harness for engine noise at the bushing in the passenger compartment (grommet on bulkhead; A-pillar plenum panel area – left ⇒ *Figure 17*) from the inside and outside using adhesive sealant/sealing compound).

3 Routing and connecting wire harness for exhaust flaps

Connections for wire harness for exhaust flaps (⇒ *Figure 27*):

- 1 – Connector for connection point (preparation of exhaust flaps, 6-pin)
- 2 – Branch for exhaust flap (left)
- 3 – Branch for exhaust flap (right)

3.1 Make a plug-in connection (6-pin) between the connection point (preparation) and exhaust flaps

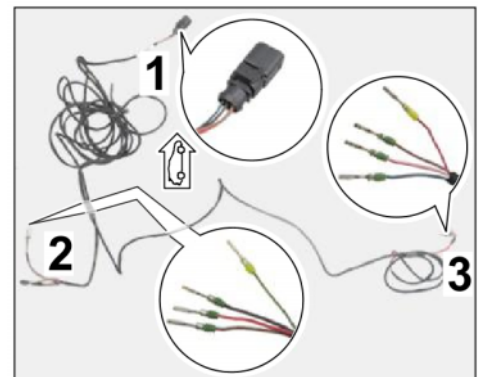

Figure 27

3.1.1 Expose the connection point (preparation = socket connector, 6-pin) in the passenger compartment of the vehicle, area of bulkhead grommet, A-pillar left (⇒ *Figure 28*).

- 1 – Foam preparation (socket connector, 6-pin)
- 2 – Grommet on bulkhead (LHD vehicle)
- 3 – Connector for wire harness for exhaust flaps (6-pin)

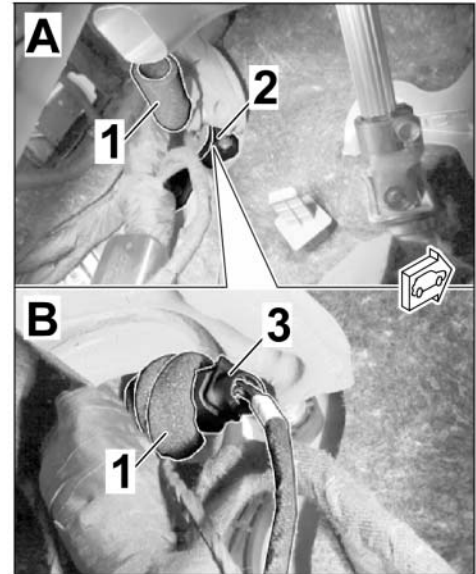

Figure 28

3.1.2 Push the foam preparation (socket connector, 6-pin) onto the line on the vehicle side.

3.1.3 Establish a connection between the plug connection preparation and the wire harness for the exhaust flaps (6-pin) ⇒ *Figure 28*.

3.1.4 Push the foam over the plug connection (6-pin).

3.2 Lay the wire harness for the exhaust flaps to the rear of the vehicle as follows

Route of the wire harness for exhaust flaps in the vehicle (⇒ *Figure 29*):

- 1 – Connection point (preparation)
- 2 – Grommet/stopper for luggage compartment floor (left)
- 3 – Grommet/stopper for luggage compartment floor (right)

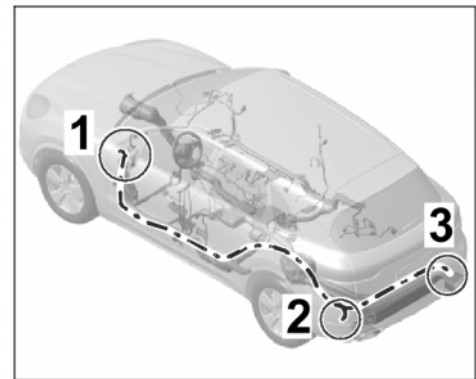

Figure 29

3.2.1 A-pillar area, left (⇒ Figure 30)

- 1 – Socket connector (6-pin, preparation)
- 2 – Pin connector (6-pin, wire harness for exhaust flaps)
- 3 – Fuses/relays (LHD vehicles)

- **LHD vehicles:** Connecting point (preparation = socket connector, 6-pin) → along wire harness A-pillar, left → beneath fuses/relays (**DO NOT** remove the relay carrier - at most loosen it.) → Door sill A-pillar, left

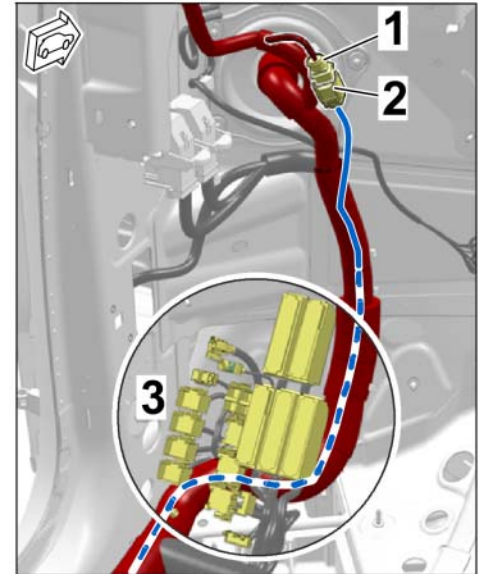

Figure 30

3.2.2 Door sill area, left (⇒ Figure 31)

- 1 – Wire harness for exhaust flaps
- 2 – Cable holder, door sill B-pillar area (left)
- 3 – Cable duct, rear door sill area (left)

- Door sill A-pillar, left → along wire harness for door sill, left (open cable ducts/holders if necessary) → wheel housing, rear left

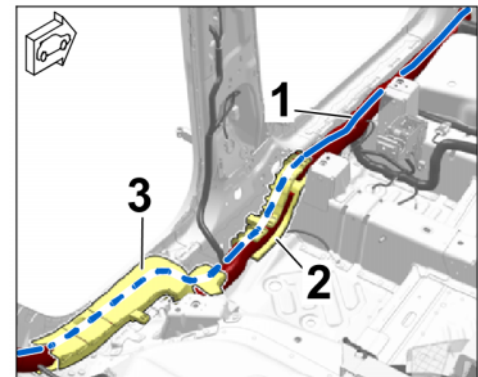

Figure 31

3.2.3 Wheel housing area. left (⇒ *Figure 32*)

- 1 – Cable duct, rear door sill area (left)
- 2 – Cable duct, rear wheel housing area (left)
- 3 – Fuse box in the boot (left)
- 4 – Grommet/stopper for luggage compartment floor, left (Ø 66.5 mm/ 2.6 in)
- 5 – Branch for exhaust flap, right side

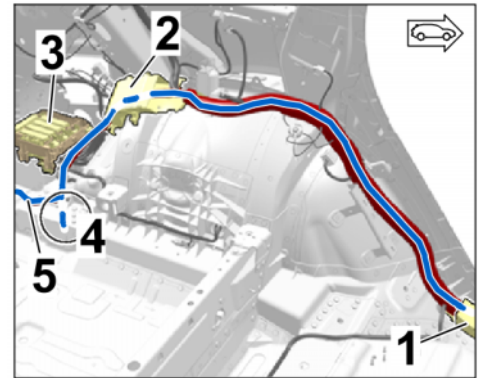

Figure 32

- Door sill, left → above wheel housing, left → branch for exhaust flap (left) to grommet/stopper for luggage compartment floor, left (beneath fuse/relay carrier) → branch for exhaust flap, right of the rear end plate

3.2.4 Rear end plate area and grommet/stopper for luggage compartment floor (⇒ *Figure 33*)

- 1 – Branch for exhaust flap (left)
- 2 – Branch for exhaust flap (right)
- 3 – Fuse box in the boot (left)
- 4 – Grommet/stopper for luggage compartment floor, left (Ø 66.5 mm/ 2.6 in)
- 5 – Grommet/stopper for luggage compartment floor, right (Ø 46 mm/ 1.8 in)

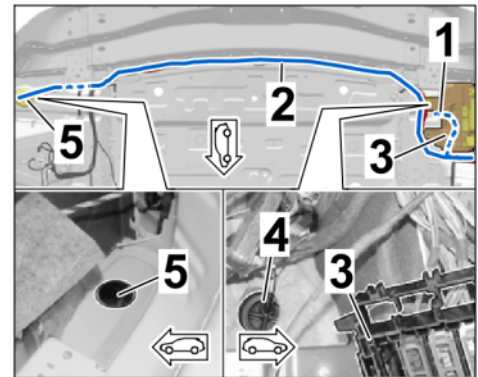

Figure 33

- Branch for exhaust flap (left) to grommet/stopper for luggage compartment floor, left (beneath fuse box in luggage compartment (left) → branch for exhaust flap on the right of the rear end plate → along rear end plate (⇒ *Figure 33 -top-*) → grommet/stopper for luggage compartment floor, right.

3.3 Lay the branch for the exhaust flap (left/right) to the underside of the vehicle

- 3.3.1 Loosen fuse box with holder in left rear boot and swivel it aside (⇒ *Figure 34*). ⇒ *Workshop Manual '978409 Loosening and securing fuse box in the luggage compartment'*

- 1 – Fuse box with holder
2 – Grommet (left = Ø 66.5 mm/ 2.6 in)

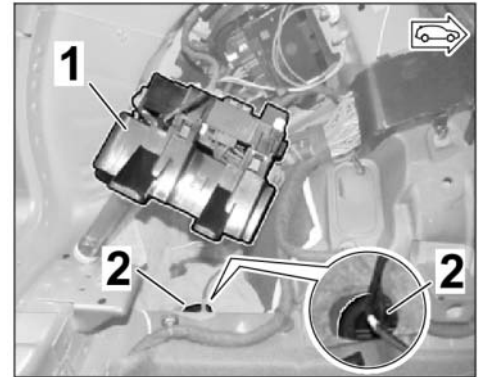

Figure 34

- 3.3.2 Loosen the heat shield on the underside of the vehicle in the area of the grommet (right/left) and stopper (right/left) and bend it down slightly.
- 3.3.3 Remove the stoppers in the luggage compartment floor (left = Ø 66.5 mm/ 2.6 in, right = Ø 46 mm/ 1.8 in). The stopper is replaced by a corresponding grommet (see parts package).
- 3.3.4 **ONLY** if a grommet with several lines is installed on the underside (including an exhaust flap branch (left/right of the standard rear silencer ⇒ *Figure 35*):

- 1 – Sleeve
2 – Branch for exhaust flap
3 – Exhaust flap (standard rear silencer)

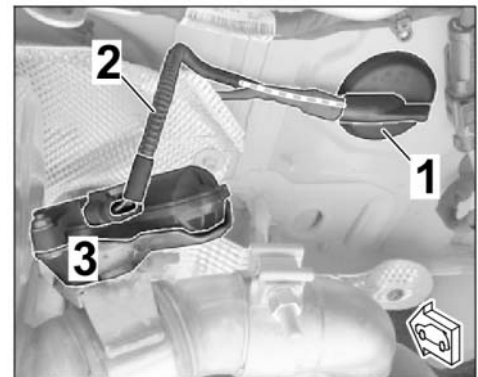

Figure 35

- Remove grommet(s) (left/right) with branches and guide it into the passenger compartment.
- Remove the connector housing from the respective exhaust flap branch (left/right of the standard rear silencer).
- Spread the grommet using a three mandrel pliers for hoses and grommets (commercially available) and remove adhesive residue from the grommet.
- **CAREFULLY** guide the exhaust flap standard branch through the grommet into the passenger compartment and wrap it with insulating tape and secure it.
- Guide the new branch for the exhaust flap (left/right) through the neck of the grommet (see also 3.3.6) **OR** through another hole in the grommet collar (⇒ *Figure 36*) **CAREFULLY** to the underside of the grommet.

- 1 - Sleeve
- 2 - Branch for exhaust flap (left/right)
- 3 - Additional electric line

3.3.5 **ONLY** if a grommet is installed with the exhaust flap branch (left/right of the standard rear silencer):

- Remove grommet(s) with branch connections to the exhaust flap (left/right) and guide it/them into the passenger compartment.
- Tie back the exhaust flap branch (left/right) with the connector and grommet on the wire harness on the vehicle side in the passenger compartment.
- Use a new grommet (left = Ø 66.5 mm/2.6 in, right = Ø 46 mm/ 1.8 in, see scope of parts) (see also 3.3.6).

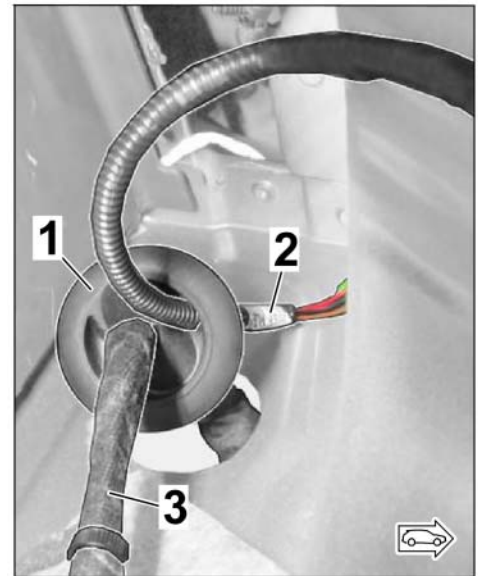

Figure 36

3.3.6 **ONLY** if stopper (left = Ø 66.5 mm/2.6 in, right = Ø 46 mm/ 1.8 in) is installed:

- Remove the stoppers (left = Ø 66.5 mm/2.6 in, right = Ø 46 mm/ 1.8 in).
- Use a new grommet (left = Ø 66.5 mm/2.6 in, right = Ø 46 mm/ 1.8 in, see scope of parts) (see also 3.3.6).

3.3.7 Guide the new branch for the exhaust flap (left/right) through the new grommet (left = Ø 66.5 mm/2.6 in, right = Ø 46 mm/ 1.8 in ⇒ *Figure 37*) using three mandrel pliers and an auxiliary line (Tekalan or Teflon tube).

- 1 - Three mandrel pliers
- 2 - Grommet, right (Ø 46 mm/ 2.6 in)

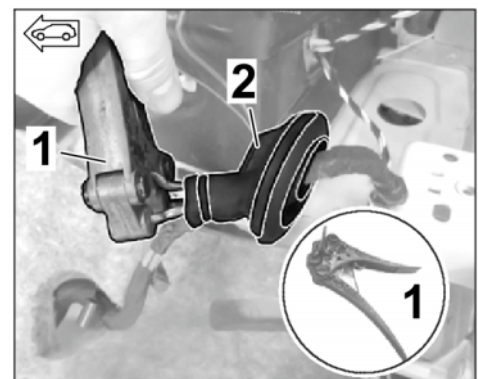

Figure 37

3.4 installing the socket housing on the exhaust flap branch

3.4.1 Release the socket housing (4-pin, see parts list) (\Rightarrow Figure 38).

- 1 – Fuse
- 2 – Plug socket (4-pin)

3.4.2 Connect the lines with female contacts and single-core seals (wire harness for exhaust flaps) in the socket housing (4-pin, see parts list) as follows:

- Left exhaust flap:

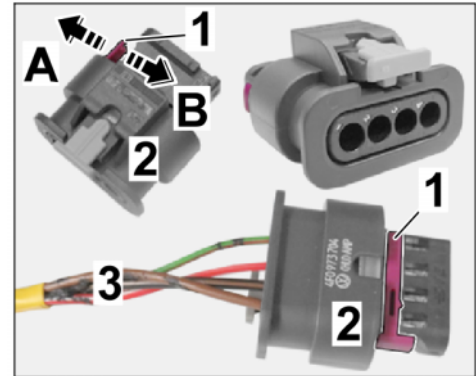

Figure 38

Plug socket (4-pin)	Line/function
Chamber 1	BN; 0.5 ² = Terminal 31 (Ground)
Chamber 2	SW/BN; 0.75 ² = Pulse Width Module (PWM)
Chamber 3	RT/WS; 0.5 ² = Terminal 87 (power supply, fuse
Chamber 4	GN/RT; 0.35 ² = Pulse Width Module out (PWM)

- Right exhaust flap:

Plug socket (4-pin)	Line/function
Chamber 1	BN; 0.5 ² = Terminal 31 (Ground)
Chamber 2	SW/BL; 0.5 ² = Pulse Width Module (PWM)
Chamber 3	RT/WS; 0.5 ² = Terminal 87 (power supply, fuse
Chamber 4	RT / SW; 0.35 ² = Pulse Width Module out (PWM)

3.4.3 Lock the socket housing (4-pin, see parts list) (\Rightarrow Figure 38).

3.4.4 Wrap cables (4 x) with insulating tape from a distance of approx. 30 mm/ 1.18 in from the connector (socket housing 4-pin) as far as the underbody.

3.4.5 Install corrugated hose 4.5 x 7.6 x X to each branch from a distance of approx. 30 mm/ 1.18 in from the connector (socket housing 4-pin) to the underbody (⇒ *Figure 39*).

- 1 – Corrugated hose, 4.5 x 7.6 x X
- 2 – Connector (socket housing 4-pin)
- 3 – Branch for exhaust flap (right)
- 4 – Tie-wrap
- X – approx. 30 mm/ 1.18 in

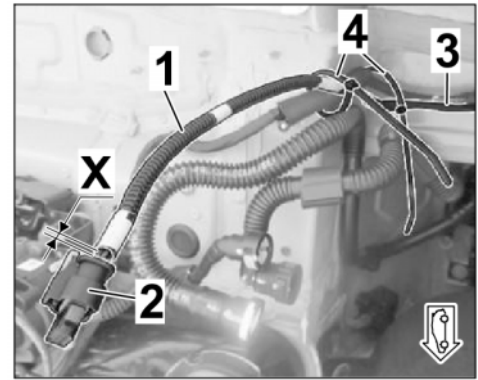

Figure 39

- Left side: Corrugated hose, 4.5 x 7.6 x 220
- Right side: Corrugated hose, 4.5 x 7.6 x 230

3.5 Check fuse assignment of exhaust flaps and engine sound pulse generator in the fuse box (left A-pillar footwell ⇒ *Figure 40*) (⇒ Cayenne Driver's Manual, section on 'Fuses')

- 1 – Fuse strip A
- 2 – Fuse strip D

3.5.1 Check that slot A4 is inserted into fuse strip A (exhaust flaps) and secure with a new fuse if necessary.

Fuse: **Nominal value 7.5 A**

3.5.2 Check that slot D3 is inserted into fuse strip D (structure-borne noise control unit, engine noise generator) and secure with a new fuse if necessary.

Fuse: **Nominal value 15 A**



Figure 40

4 Install new exhaust system

4.1 Install new exhaust pipe(s) with front silencer with a new seal and new spring/tab assembly (⇒ Figure 41):

- 1 – Spacer tube \varnothing 24 x 32
- 2 – Tab AL552
- 3 – Compression spring
- 4 – Washer, 8.4 x 24 x 2
- 5 – Cheese head bolt with multiple-tooth socket, M8 x 50
- 6 – Spacer pipe, \varnothing 30 x 16
- 7 – Rubber bush, \varnothing 42 x 29

- Vehicles **WITHOUT** PPF: ⇒ *Workshop Manual '267319 Removing and installing catalytic converter (V6 monoturbo)'*
- Vehicles **WITH** PPF: ⇒ *Workshop Manual '267319 Removing and installing catalytic converter with particle filter (V6 monoturbo)'*

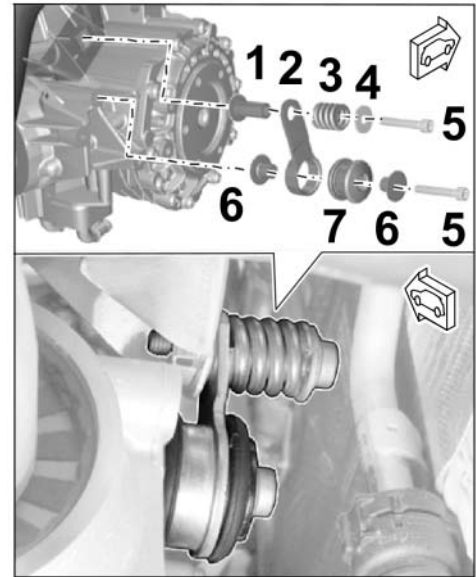

Figure 41

Secure catalytic converter exhaust pipe(s) on the transmission support using restraining strap for securing loads, for example, to prevent them from bending down.

4.2 Install new center silencer with new clamping sleeve \varnothing 65 x 88 (2 x – vehicles WITH petrol particulate filter) or clamping sleeve \varnothing 75 x 88 (1 x – vehicle WITHOUT petrol particulate filter). ⇒ *Workshop Manual '260119 Removing and installing exhaust system (V6 monoturbo)'*

- 1 – Clamping sleeve, \varnothing 75 x 88
- 2 – Holder for center silencer, front, right
- 3 – Center silencer (WITHOUT PPF)
- 4 – Center silencer retaining ring
- 5 – Clamping sleeve, \varnothing 65 x 88
- 6 – Rear silencer
- 7 – Sports tailpipes, Black chrome-plated, left
- 8 – Sports tailpipes, Black chrome-plated, right

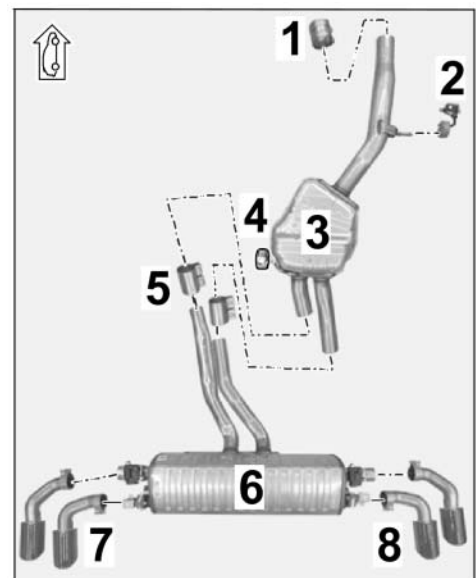

Figure 42

- Hexagon collar bolt, M10 x 30 (center silencer holder): **Tightening torque 49 Nm**
- Clamping sleeve, \varnothing 65 x 88 / \varnothing 75 x 88: **Tightening torque 30 Nm**

- 4.3 Install new rear silencer with a new clamping sleeve, Ø 65 x 88 (2 x). ⇒ *Workshop Manual '263355 Replacing rear silencer'*
 - Hexagon collar bolt, M8 x 25 (rear silencer holder): **Tightening torque 23 Nm**
 - Clamping sleeve, Ø 65 x 88: **Tightening torque 30 Nm**
- 4.4 Connect electric plug connections for servo motor for exhaust flap (left/right).
 - 4.4.1 Pull the excess branch wire for the exhaust flap (left/right) towards the grommet in the floor of the vehicle.
 - 4.4.2 Seal the line bushing for the exhaust flap in the grommets (left/right) from the inside and outside using sealing cord.

- 4.5 Install new sports tailpipes (silver or black) and align them with the rear apron. ⇒ *Installation and Conversion Instructions '263400 Sports tailpipe, twin-branch – Silver (OP3)/Black (OP6)'*

- 1 – Sports tailpipe – inner (right)
- 2 – Sports tailpipe – outer (right)
- 3 – Exhaust system cover (rear apron)

- 4.5.1 Check that the gap between the new sports tailpipes and exhaust system cover (rear apron – left and right side of vehicle) is symmetric and constant and adjust it if necessary.

⇒ *Figure 43-Z-*: **Control value 21 mm +/-1 mm**

- 4.5.2 Check spacing of inner/outer sports tailpipe (left and right side of vehicle) and make adjustments if necessary.

⇒ *Figure 43-Za-*: **Control value 11 mm +/-1 mm**

- 4.5.3 Tighten lens-head screw, M6 x 12 (underside of sports tailpipe cover).

Tightening torque 8 Nm (6 ftlb.) +/-1 Nm (+/-0.5 ftlb.)

- 4.6 Install all covers to the underbody of the vehicle.

5 Concluding work for vehicle interior/engine compartment

- 5.1 Secure routed wire harnesses (motor noise/exhaust flaps) in the vehicle to existing lines/components with tie-wraps without tensile stress and so that no chafing occurs.
- 5.2 Install trim panels in the boot and C-pillar area.
- 5.3 Install trim panels in the B-pillar and A-pillar area (left side).

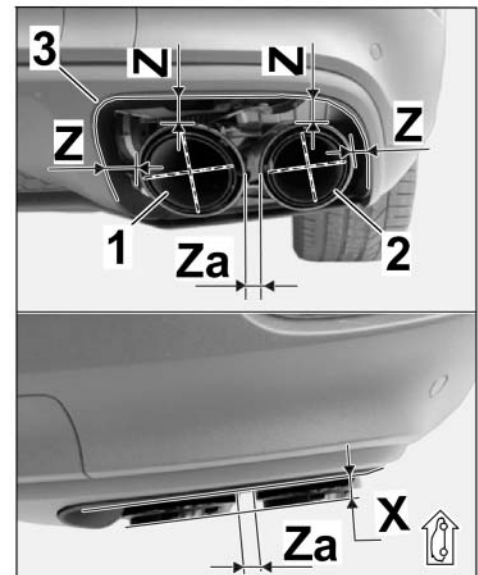

Figure 43

- 5.4 Installing the seat assembly
 - 5.4.1 Carefully lift the front seat into the vehicle via the boot and install it with a new cheese head bolt. ⇒ *Workshop Manual '720119 Removing and installing front seat'*
 - 5.4.2 Carefully lift the 2/3-split folding rear seat into the vehicle via the boot and install it with a new cheese head bolt. ⇒ *Workshop Manual '724819 Removing and installing rear seat'*
 - 5.4.3 Install padding for rear seat surface (2/3-seat) with new fixing clip. ⇒ *Workshop Manual '74491901 Removing and installing padding for rear seat surface (2/3-split folding rear seat)'*
- 5.5 Complete the engine compartment area.
 - 5.5.1 Install air cleaner housing. ⇒ *Workshop Manual '242519 Removing and installing air cleaner housing'*
 - 5.5.2 Install engine cover (design cover) (V6 Turbo). ⇒ *Workshop Manual '108319 Removing and installing engine cover (design cover) (V6 Turbo)'*
 - 5.5.3 Install filler neck on windscreen-washer reservoir. ⇒ *Workshop Manual '926019 Removing and installing windscreen-washer reservoir'*
- 5.6 Complete the plenum panel area.
 - 5.6.1 Install cowl panel cover. ⇒ *Workshop Manual '508719 Removing and installing cowl panel cover'*
 - 5.6.2 Install front lid seal. ⇒ *Workshop Manual '553319 Removing and installing front lid seal'*
 - 5.6.3 Install wiper arms. ⇒ *Workshop Manual '922519 Removing and installing wiper arm'*
 - 5.6.4 Install moulding for windscreen. ⇒ *Workshop Manual '666119 Removing and installing moulding for windscreen'*

Coding: 6 Coding/programming sports exhaust system - Silver (OP8)/Black (OP9)

NOTICE

Voltage drop

- Risk of irreparable damage to control unit
 - Risk of damage to control unit
 - Fault entries in the control unit
 - Coding in the control unit is aborted
 - Malfunctions in control unit, even during programming
- ⇒ Switch off the ignition and remove the ignition key before disconnecting the control unit.

- ⇒ Ensure that the power supply is not interrupted during programming.
- ⇒ Connect a battery charger with a current rating of at least Nominal value 90 A to the vehicle battery.

6.1 Preparatory work – Coding

NOTICE

Control unit programming will be aborted if the Internet connection is unstable.

- An unstable Internet connection can interrupt communication between PIWIS Tester III and the vehicle communication module (VCI). As a result, control unit programming may be aborted.
- ⇒ During control unit programming, always connect PIWIS Tester III to the vehicle communication module (VCI) via the USB cable.

6.1.1 **9900 - PIWIS Tester 3** must be connected to the vehicle and switched on.

6.1.2 Switch on ignition **AND** hazard warning lights on the vehicle.



Information

The **9900 - PIWIS Tester III** instructions take precedence since the description may be different with later Tester releases.

The procedure described here has been structured in general terms; different text or additions may appear on the **9900 - PIWIS Tester III**.

6.1.3 Select the "Diagnostics" menu item on the PIWIS Tester.

6.1.4 If **9900 - PIWIS Tester 3** is connected correctly, a connection to the vehicle will be established: "Cayenne" model line is detected.

6.1.5 Press •F12" to go to the control unit search screen.

6.1.6 Confirm the question: "Create vehicle analysis log (VAL)?" with "Yes" = •F12" .

6.1.7 Select "KD-FAP" in the next menu item and press •F8" to start.



Information

The function is **ONLY** available when the Tester is online!

6.2 Enter the new vehicle equipment in the vehicle data using "PIWIS Online"

6.2.1 Press •F7" in the control unit overview to switch to the "Additional menu".

6.2.2 Select the function "Maintenance of vehicle data with PIWIS ONLINE".

A message appears informing you that the "Actual" (vehicle) data and "Required" (PIWIS Online) data will be compared.

Press •F12" to continue.

6.2.3 Confirm the message "The vehicle data was compared with PIWIS Online. Significant differences were found" with •F12" .

6.2.4 Look for the option "INTERIOR SOUND MEASURES (VW SILENCERS)" in the "Family" column.

Select the option "2HB – INTERIOR SOUND MEASURES (SHAKER)" from the drop-down menu in the "Value" column.

6.2.5 Look for the option "EXHAUST TAILPIPE" in the "Family" column.

Select "OP8 – SPORTS EXHAUST SYSTEM – STAINLESS-STEEL TAILPIPES" or "OP9 – SPORTS EXHAUST SYSTEM – BLACK TAILPIPES" from the drop-down menu in the "Value" column, depending on the installed option.

Press •F12" to continue.

6.2.6 A table containing the coding value and the columns "new value" and "old value" is displayed in the overview. Press •F8" to continue.

6.2.7 Data is then written/stored. The following messages appear one after the other:

- Transferring vehicle data to PIWIS Online.
- Writing and transferring vehicle data to the vehicle.
- Vehicle order was written successfully.
- A check was performed in order to check whether control units have to be coded or programmed as a result of the changes that were made.

6.3 Code/program the new vehicle equipment.

6.3.1 Confirm the table containing a list of control units that must be coded/programmed by pressing •F12" .

6.3.2 Individual data records will be loaded, depending on the number of control units to be coded/programmed.

Wait until the message "Creating backup documentation. Please wait..." and "Coding was completed successfully" appears. Press •F12" to continue.

Repeat the process for other control units if necessary.

6.3.3 Wait until the message "Adaptation of the control units is complete." appears and check the coding status of the control units in the table that is displayed.

Continue by pressing •F12" to return to the control unit overview.

6.4 Read out the fault memories of all systems, work through any existing faults and erase the fault memories. ⇒ *Workshop Manual '0335IN Diagnostic maintenance: diagnostic system and maintenance inter...'*

6.5 Switch off ignition and disconnect **9900 - PIWIS Tester 3**.

6.6 Drive the vehicle off the lifting platform.

7 Perform "Sports exhaust system" function test

7.1 Start the engine.

7.2 Activate/deactivate the sports exhaust system, depending on vehicle equipment, using the following option:

- Porsche Communication Management: Select the menu "Car" → "Drive" → "Sports exhaust system".
- Porsche Communication Management: Select "SPORT" or "SPORT PLUS"

7.3 Switching off ignition

26 01 31 00: **ONLY** for vehicles WITHOUT Petrol Particulate Filter (–PPF):

–Sports exhaust system (1 x) retrofitted–

Labor time: **686 TU**

Includes: Installing engine noise pulse sender and control unit;
Routing and connecting electric wire harnesses;
Installing exhaust pipe with front silencer (WITHOUT PPF);
Installing new center and rear silencers
; Installing and aligning new sports tailpipes (4 x);
Coding sports exhaust system;
Reading out fault memory and correcting and clearing faults.

Without: Test drive

26 01 31 03: **ONLY** for vehicles WITHOUT Petrol Particulate Filter (+PPF):

–Sports exhaust system (1 x) retrofitted–

Labor time: **782 TU**

Includes: Installing engine noise pulse sender and control unit;
Routing and connecting electric wire harnesses;
Installing new exhaust pipes with front silencer (WITH PPF, left
and right side);
Installing new center and rear silencers
; Installing and aligning new sports tailpipes (4 x);
Coding sports exhaust system;
Reading out fault memory and correcting and clearing faults.

Without: Test drive

Important Notice: Technical Bulletins issued by Porsche Cars North America, Inc. are intended only for use by professional automotive technicians who have attended Porsche service training courses. They are written to inform those technicians of conditions that may occur on some Porsche vehicles, or to provide information that could assist in the proper servicing of a vehicle. Porsche special tools may be necessary in order to perform certain operations identified in these bulletins. Use of tools and procedures other than those Porsche recommends in these bulletins may be detrimental to the safe operation of your vehicle, and may endanger the people working on it. Properly trained Porsche technicians have the equipment, tools, safety instructions, and know-how to do the job properly and safely. Part numbers listed in these bulletins are for reference only. The work procedures updated electronically in the Porsche PIWIS diagnostic and testing device take precedence and, in the event of a discrepancy, the work procedures in the PIWIS Tester are the ones that must be followed.

© 2021 Porsche Cars North America, Inc.