



PORSCHE



# Product Information

Porsche 911 GT3



## **Foreword**

The Porsche 911 GT3 is a road sports car offering exceptional performance in both road and racing use. Following the launch of the first 911 GT3 in 1999 and the follow-up version in 2004, the new 911 GT3 is now being rolled out on the basis of the 997 model line, featuring a further improvement in power and performance.

This training brochure contains comprehensive information on the new 911 GT3 and an assessment of the strategic competition.

The aim of this brochure is to provide the international Porsche sales organisation with the ability to advise customers extremely competently concerning new 911 GT3. To this end, the information is presented in particularly detailed form. In addition to presenting the technical features, the brochure also outlines the attendant product merits. This Product Information thus includes the full scope of information to enable selling geared to the customers' or prospects' needs and purchasing motives. This knowledge should, of course, be used selectively - that is, tailored to the individual customer's needs - when offering professional advice.

Dr. Ing. h.c. F. Porsche Aktiengesellschaft  
Marketing & Sales Training



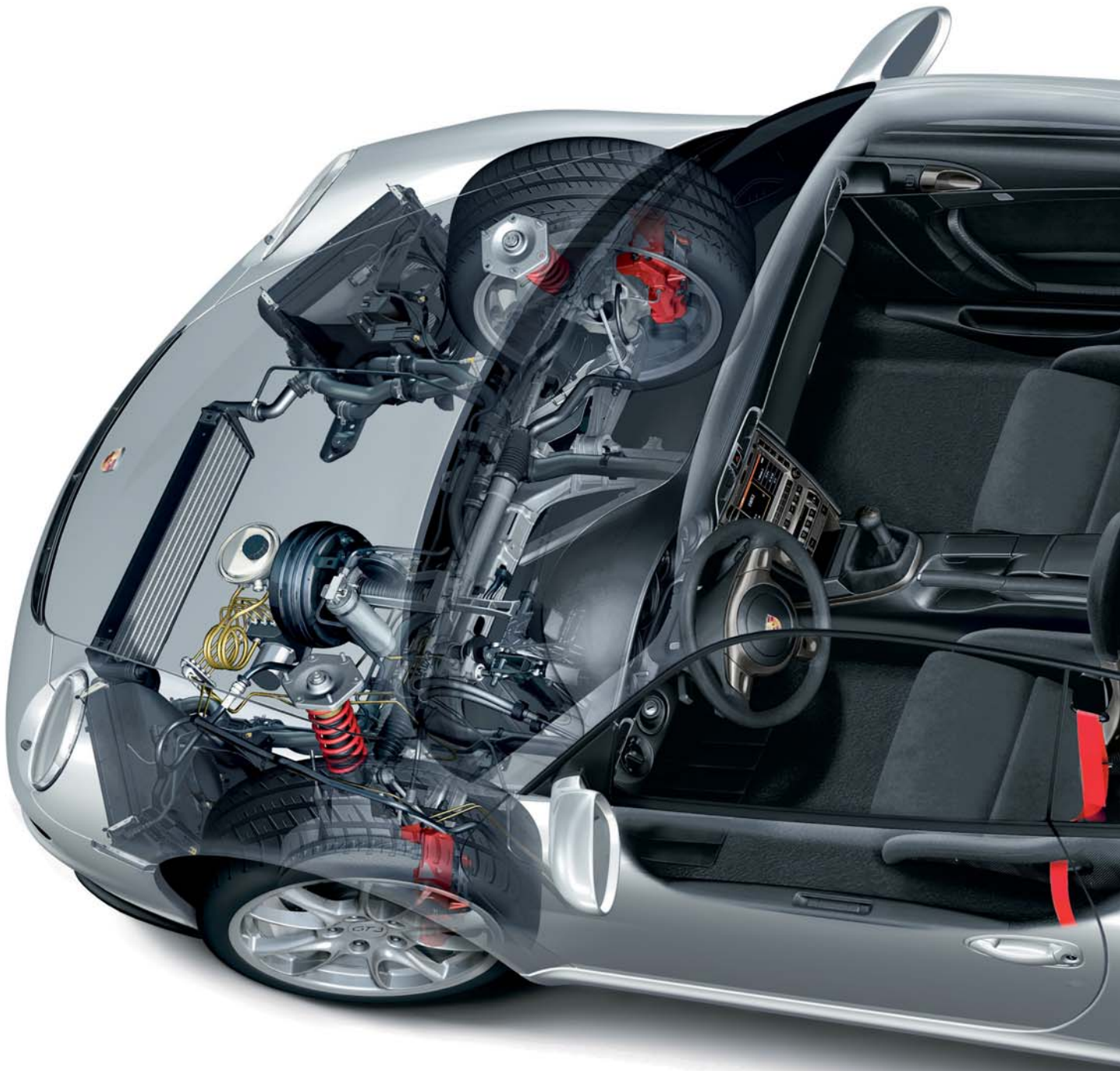





# Contents

<b>1</b>	<b>Overview</b>	<b>1</b>
1.1	Development objectives	3
1.2	The key highlights	4
1.2.1	Design	4
1.2.2	Performance	8
1.2.3	Product description	11
1.2.4	Product differentiation	14
<b>2</b>	<b>Engine</b>	<b>15</b>
2.1	Basic engine	18
2.2	Induction system	20
2.3	Exhaust system	21
2.4	Engine management	22
<b>3</b>	<b>Power transmission</b>	<b>23</b>
3.1	Transmission	23
3.2	Locking differential	23
<b>4</b>	<b>Chassis</b>	<b>24</b>
4.1	Porsche Active Suspension Management (PASM)	25
4.2	Traction Control/ABS	26
4.3	Front axle	27
4.4	Rear axle	28
4.5	Steering	28
4.6	Brake system	29
4.7	Wheels and tyres	30
<b>5</b>	<b>Body</b>	<b>32</b>
5.1	Body-in-white	33
5.2	Front apron	34
5.3	Rear apron	35
5.4	Rear lid with rear wing	35
5.5	Fuel tank	36
5.6	Luggage compartment	36
5.7	Interior	37
5.8	Clubsport package	40
<b>6</b>	<b>Aerodynamics</b>	<b>41</b>
<b>7</b>	<b>Electrics</b>	<b>43</b>
7.1	Battery	43
7.2	Lighting	43
7.3	Instruments	44

<b>8</b>	<b>Audio and communication</b>	<b>.45</b>
8.1	CD radio and loudspeakers	.45
8.2	Antenna system	.45
8.3	PCM with navigation (option)	.46
8.4	Sound Package Plus (option)	.46
8.5	Telephone module for PCM (option)	.47
8.6	Telephone preparation for mobile phone (option)	.47
8.7	Chrono Package (option)	.47
<b>9</b>	<b>Safety</b>	<b>.48</b>
9.1	Active safety	.48
9.2	Passive safety	.48
<b>10</b>	<b>Equipment</b>	<b>.49</b>
10.1	Standard equipment (EU model)	.49
10.2	Optional extras	.52
<b>11</b>	<b>Colours</b>	<b>.56</b>
11.1	Exterior colours	.56
11.2	Interior colours	.57
<b>12</b>	<b>Cost of Ownership</b>	<b>.58</b>
12.1		
12.2		
12.3	Overview Cost-of-Ownership	.59
<b>13</b>	<b>Technical data</b>	<b>.60</b>
<b>14</b>	<b>Core competition</b>	<b>.65</b>
14.1	External car comparison	.65
14.2	Key product merits	.73
14.2.1	Key advantages of the new 911 GT3 over the current BMW M3 Coupé	.73
14.2.2	Key advantages of the new 911 GT3 over the BMW M6 Coupé	.75
14.2.3	Key advantages of the new 911 GT3 over the Ferrari F430	.76
14.2.4	Key advantages of the new 911 GT3 over the Dodge Viper SRT-10 Coupé	.77
14.2.5	Key advantages of the new 911 GT3 over the Corvette Z06	.79
14.3	Overview of USPs	.80





Fig. 1: The new 911 GT3

**Note:**

All information provided in this document is correct as at December 2005.

Porsche reserves the right to alter the design, technical specification, prices, equipment and final scope of delivery at any time prior to the market launch of the 911 GT3. The descriptions in this section are based on the EU model.

## 1 Overview

In the space of a few years, "GT3" has become a generic term. It covers a range of vehicles extending from the top-class road sports car through the near-series racing car for the Porsche Manufacturer's Cups and worldwide Clubsport to the corresponding vehicle for international GT sport. The latest additions to this sporting family go by the names of 911 GT3 and 911 GT3 Cup.

On the basis of the new 911 generation and the current 911 GT3 Cup generation of vehicles, the new 911 GT3 has also been developed for customers who seek a car offering exceptional performance on race circuits in particular. The new 911 GT3 is a combination of production sports car and near-series racing car. The high-power naturally aspirated engine of the 911 family, the chassis offering enhanced driving dynamics and the finely tuned aerodynamics ensure unique agility and performance for the new 911 GT3.



Fig. 2: The new 911 GT3

While on the one hand adopting key elements from the current 911 Carrera models, the new 911 Turbo and the 911 GT3 Cup, the new 911 GT3 also offers a basis for further development measures on the racing cars. Similarly to the 911 GT3 (996), the new 911 GT3 also provides living proof of the fruitful inter-relationship between the road and the race circuit.

## 1.1 Development objectives

The development objectives for a new model from the area of Porsche Motorsport naturally focus on the features of relevance to driving dynamics. A particular challenge was the task of realising “pure driving dynamics” at the highest level.

Successful realisation of this task hinged on intensive and systematic technology transfer from the Porsche racing cars to the new 911 GT3. A Porsche 911 GT3 is thus subject to development objectives which also apply to motor racing vehicles:

- High engine power combined with lowest possible total vehicle weight
- Maximum traction
- Optimum aerodynamics (above all reduced lift / downforce) in conjunction with improved balance
- Coordination of the overall ratio spread (transmission and dynamic rolling radius of the tyres) in order to convert the available tractive power into the best possible acceleration
- Chassis tuning ensuring direct feedback to the driver for particularly precise handling



Fig. 3: The new 911 GT3

On the basis of these objectives, the following key development focuses were defined for the new 911 GT3:

- Design of an active chassis offering the highest levels of driving dynamics and agility on the road. Design of the individual components with a priority on race circuit use (e.g. adjustability of the axle geometry)
- Development of a special new wheel/tyre combination with a further increase in width on the rear axle accompanied by reduced component weight in comparison to the 911 GT3 (996)
- Enhanced braking performance incl. adaptation of the Porsche Ceramic Composite Brake (PCCB) as an optional extra
- Development of a Traction Control (TC) system modelled on the Carrera GT
- Improvement of aerodynamics through the development of an Aerokit based on the body of the current 911 Carrera generation, with the aim of achieving neutral lift or downforce throughout the vehicle speed range
- Optimisation of the power potential of the 6-cylinder horizontally opposed engine with a displacement of 3.6 l, according due consideration to the worldwide exhaust and noise emission regulations, incl. USA. Realisation via a newly developed variable intake system and a sports exhaust system with reduced exhaust backpressure
- Reduction of moving masses as a prerequisite for increasing the engine speed potential to 8,400 rpm
- Realisation of a high specific output with the aim of achieving an increase of approx. 8% over the 911 GT3 (996)
- Attainment of a specific torque of > 110 Nm/l
- Reduction in engine weight of approx. 10 kg

- Adaptation of the transmission to the higher loads and the revised high engine speed concept with the aim of attaining even more dynamic performance particularly in the high vehicle speed range
- More pronounced differentiation of the interior from that of the current 911 Carrera basic models by means of a further elaborated colours and materials concept
- High practicality, incl. high active and passive safety and low fuel consumption
- Provision of a comprehensive customisation programme



Fig. 4: The new 911 GT3

## 1.2 The key highlights

The key highlights and product features are summarised below.

### 1.2.1 Design

The design of the new 911 GT3 is in keeping with its intended character as a thoroughbred production sports car and near-series racing car. The striking design communicates the enormous performance potential of the new 911 GT3 while also fulfilling all the aerodynamic functions which are required in order to realise this potential. In terms of dynamic appearance, aerodynamics and distinctive design, the new 911 GT3 offers excellent prospects for a continuation of the 911 GT3 success story.

### Front

The striking flared outer cooling-air inlets are defining features of the new front apron. They lend the new 911 GT3 a powerful appearance and ensure the required supply of cooling air. Their design, including the vertical bars, provides the new 911 GT3 with its distinctive character within the 911 model range. The slightly protruding middle cooling-air inlet extends up to the spoiler lip and forms a wedge shape which enhances the car's aerodynamic efficiency. The middle cooling-air inlet is further emphasized by the assembled joint between front apron and spoiler lip. The wide spoiler lip supports downforce at the front axle and its large openings additionally help to cool the front brake system.



Fig. 5: The new 911 GT3

A further striking design feature of the new 911 GT3 is the additional air outlet in front of the luggage compartment lid. This outlet has been adapted from the 911 GT3 (996) and is exclusive to the new 911 GT3 within the current 911 model range. It directs the exhaust air from the middle cooler upwards, thereby additionally supporting aerodynamic downforce at the front axle.

#### **Side view**

The new 911 GT3 is instantly recognisable as belonging to the 911 model range by virtue of its classic 911 silhouette. A distinctive side view results above all from the 30 mm lower position of the vehicle in comparison to the 911 Carrera, the muscular look of the fixed rear wing and the unique wheel design. The new one-piece 19" GT3 wheels have been evolved on the basis of the highly successful design of the generation of 18" GT3 wheels featured on the previous model.



Fig. 6: The new 911 GT3



## Rear wing

The fixed rear wing is a traditional element of all 911 GT3 models and constitutes the most striking design feature of the new 911 GT3, along with the front apron. The sideblades follow the contours of the vehicle's rear section and the curves are a perfect copy of the lines of the rear wings. The winglets (additional wing profiles) in the lower part of the sideblades integrate the rear wing on a visual level as well as making a crucial contribution to aerodynamic performance. In addition to its functional shaping, the rear wing also lends the new 911 GT3 its hallmark powerful appearance. Two additional ram air boxes are located on the rear lid in front of the rear wing. These represent a further design feature of the new 911 GT3, also enabling more efficient air intake for the engine and an improved supply of cooling air to the engine compartment.



Fig. 7: The new 911 GT3



Fig. 8: The new 911 GT3

## Rear end

The 911 GT3 premieres a unique rear end with centrally positioned tailpipe and additional air outlet openings. The central dual tailpipes represent the main distinguishing feature of the new 911 GT3 in contrast to the other models of the current 911 model range. They are generously dimensioned, extend from the middle of the rear end and lend the rear of the new 911 GT3 a muscular appearance. Adapted from the motor racing design of the 911 GT3 Cup vehicles, this design feature provides a visual reference to the flow- and resistance-optimised sports exhaust system on the new 911 GT3.

Two narrow air outlet openings are integrated into the sides of the rear end, continuing the design style of the tail lights above. A striking lip subsequently emerges from these openings, extending to the tailpipes, for which it provides a harmonious surround. The outlet openings perform thermal ventilation of the mufflers and catalytic converters located in the side wings while also improving the aerodynamics of the air flow around the new 911 GT3.





Fig. 9: Interior

### Interior

The interior equipment of the new 911 GT3 is based on the current 911 generation, borrowing features from the 911 GT3 RS (996) and the Carrera GT. A characteristic feature of the interior in the new 911 GT3 is the items which are additionally finished in Alcantara, such as the steering wheel rim, shift and handbrake lever grip and the seat inserts. This integrated material concept, which was first featured in the 911 GT3 RS (996), enhances the appearance of the interior by establishing associations with motor racing while at the same time improving functionality by offering a better grip and slip resistance.

The interior of the new 911 GT3 is further enhanced by an instrument cluster featuring a new colour concept based on the Carrera GT. The pointers and increment markings are in yellow and the rev counter in the middle is highlighted by a titanium-coloured dial showing the "GT3" logo.

As for the 911 GT3 (996), a Clubsport package comprising the following features is also available as a no-cost option for the new 911 GT3 (not available in the USA): Bolted-on roll cage at rear, red 6-point belt for driver's side, fire extinguisher with holder and preparation for a battery main switch. For use in racing events under FIA GT rules, both the battery main switch and special side extension bars for roof and A-pillars (to

extend the safety cage) are available as racing parts from the Porsche motor racing department.

The Clubsport package is used above all on race circuits. In order to exploit all the given ergonomic advantages here, the Clubsport package is only available in conjunction with the lightweight carbon-fibre bucket seats option. This combination offers a high standard of vehicle safety and a high level of lateral support for the seats, in line with the needs of motor racing. In conjunction with the Clubsport package, the seats, which originate from the Carrera GT, are upholstered in a highly flame-retardant material instead of leather.

In addition to the new interior design, elements from the current 911 generation also improve ergonomics inside the car. The lower seat position with sports seats, the more forward positioning of the pedals and the additional height adjustment facility for the steering wheel, for example. Also new is the modified side airbag system with separate head and thorax airbags.

The new 911 GT3 is fitted as standard with sports seats incl. thorax airbag. Lightweight carbon-fibre bucket seats are optionally available. The design concept for these seats originates from the Carrera GT and has been adapted for the new 911 GT3. As these seats are not equipped with a thorax airbag, when ordering the lightweight bucket seats special door panels including shock-absorbing impact elements (so-called “door pads”) are additionally supplied as standard, in order to ensure a high level of side impact protection. The adaptive sports seats which are familiar from the current 911 generation are additionally available as an option. Like the standard sports seats and the lightweight bucket seats, these feature an insert finished in Alcantara on the new 911 GT3.

## 1.2.2 Performance

The 911 GT3 is the most agile vehicle within the 911 model range, offering the highest performance in particular on race circuits with its naturally aspirated engine. Apart from an excellent chassis and running gear, low weight and a drive concept geared to excellent driving dynamics are also crucial to achieving such performance. The right combination of engine and transmission plays a vital role here. The concept of a light, high-revving naturally aspirated engine with a manual transmission featuring short transmission ratios represents a successful formula in motor racing, too. Development of the drive for the new 911 GT3 thus focused on high specific output and optimisation of the high engine speed concept introduced in the 911 GT3 (996).

With a maximum engine speed of 8,400 rpm, the new 911 GT3 is among the absolute front runners in its direct competitive environment. Its specific output of 84.7 kW/l (115.3 bhp/l) is among the highest levels ever achieved by naturally aspirated engines for vehicles licensed for road use and surpasses all the direct competitors of the new 911 GT3 with naturally aspirated engine. This level of output is dependent not only on high revving stability of the engine, but above all on excellent aspiration (gas cycle). The low flow resistance of all components is to be emphasized here, particularly the new exhaust system with central dual tailpipes. This set-up results in the following performance data:

		<b>New 911 GT3</b> (997)	911 GT3 /GT3 RS (996)	911 Carrera S (997)
Displacement	cm <sup>3</sup>	<b>3,600</b>	3,600	3,824
Max. power	kW (bhp) at rpm	<b>305 (415)</b> <b>7,600</b>	280 (381) 7,400	261 (355) 6,600
Maximum torque	Nm at rpm	<b>405</b> <b>5,500</b>	385 5,000	400 4,600
Maximum engine speed	rpm	<b>8,400</b>	8,200	7,300

The engine of the new 911 GT3 is essentially a development of the 6-cylinder horizontally opposed engine familiar from the 911 GT3 (1996) with a displacement of 3.6 l, which was originally based on the engine from the 911 GT1. Its established key characteristics are the classic dry sump lubrication with external engine oil tank, titanium connecting rods, forged pistons, VarioCam and small tappets which are able to cope with high engine speeds. A new feature is a variable intake system with two tuning flaps (911 GT3/1996: one tuning flap), which combines with a sports exhaust system featuring reduced back-pressure to enable an even more efficient gas cycle.

The new 911 GT3 comes with a "SPORT" button as standard for the first time. When this button is pressed, Traction Control (vehicle stabilisation system during acceleration – see following sections for further details) is set to a sporty mode and the torque in the mid-rev range is noticeably increased. The torque is raised by up to 25 Nm between approx. 3,000 and 4,200 rpm, while the maximum torque of 405 Nm remains unchanged at 5,500 rpm. This increase in torque is achieved by an additional reduction in exhaust backpressure in the sports exhaust system and an attendant improvement in the gas cycle.

The new 911 GT3 comes with a reinforced six-speed manual transmission as standard with steel synchroniser rings in 3rd to 5th gear on the basis of the 911 GT3 (1996). The optimised high engine speed concept has enabled the transmission ratios of 2nd to 6th gear to be reduced. This results in a further improvement in power transmission after changing gear when accelerating. All



Fig. 10: The new 911 GT3

shift throws on the new 911 GT3 have been shortened once again in the interest of dynamic gear changing.

The chassis of the new 911 GT3 comes with actively adjustable dampers as standard. The Porsche Active Suspension Management system (PASM) has been adapted specially for the new 911 GT3 to enable extremely sporty performance and superior handling on race circuits, too. The basic tuning of the new 911 GT3 (PASM in Normal mode) is comparable to the sporty mode of the 911 Carrera models and offers a good basis for high driving dynamics also when driving on race circuits which include uneven surfaces (e.g. the Nord-schleife of the Nürburgring). For a further increase in driving dynamics, the PASM Sport mode in the new 911 GT3 offers a chassis tuning option designed especially for race circuits with even surfaces.

As on the 911 GT3 (1996), the anti-roll bars, the camber and toe are also individually adjustable. The suspension system incl. vehicle height can also be equipped with racing springs to enable adaptation to the individually desired handling characteristics. (Note: These modifications are only permissible in off-road use, as they affect the vehicle's handling characteristics substantially).

To increase driving stability during acceleration, the new 911 GT3 is equipped with Traction Control (TC) with ABD (automatic brake differential), ASR (anti-slip regulation) and MSR (engine drag torque control). This system comes as standard and is used in a similar manner on the Carrera GT. Traction Control can be switched to a sporty set-up with the "SPORT" button or switched off completely with the "TC OFF" button. In conjunction with the familiar ABS anti-lock brake system, the new 911 GT3 is now equipped with an integrated system for straight-line stability and overall driving stability during both braking and acceleration, particularly in adverse weather



Fig. 11: The new 911 GT3

conditions such as rain or when varying levels of grip apply on the road surface.

Similarly to the 911 GT3 (1996), the new 911 GT3 also comes with an asymmetric locking differential as standard. The locking values are 28% (traction) and 40% (overrun). These values have been changed slightly in comparison to the previous model (40% traction, 60% overrun) and adapted to the specific handling of the new 911 GT3 with improved driving dynamics. The asymmetric locking differential offers high traction in extreme driving situations on varying road surfaces, improved driving stability during load changes when cornering and increased agility in bends at high levels of lateral acceleration.

The steering corresponds to that of the new 911 generation and features a variable steering ratio. This provides for increased agility on winding stretches of road and improves driving stability at high speeds. The brake system of the new 911 GT3 has been optimised on the basis of the familiar brake system from the 911 GT3 (1996) and now features a brake disk diameter of 350 mm on the front and rear axle (911 GT3 [1996]: 350/330 mm). The optional Porsche Ceramic Composite Brake (PCCB) system has also been optimised and, similarly to on the new 911 Turbo (1997), features brake disks with a diameter of 380 mm on the front axle (911 GT3 [1996]: 350 mm).

The wheels take up the “GT3” design which is familiar from the 911 GT3 (1996). For the new 911 GT3, they have been increased from 18" to 19" and widened on the rear axle from 11" to 12". The sports tyres which come as standard, corresponding to those on the 911 GT3 (1996) and including wider tyres on the rear axle, further enhance the already exceptional performance potential of the new 911 GT3 (the special tyre tread results in an increased danger of aquaplaning on wet surfaces).

Low weight for high performance and a long range were also specified objectives for the new 911 GT3. These objectives are achieved by means of the narrow body based on the current 911 Carrera models and the body-in-white of the current 911 Carrera 4 models. As on the 911 GT3 (1996), this combination enables a low vehicle weight, low drag and road resistance and enlargement of the fuel tank to 90 l (911 GT3 [1996]: 89 l). The aluminium luggage compartment lid (corresponding to the lid on the 911 Carrera models) and the aluminium doors (as on the new 911 Turbo) also entail weight advantages and enable the low total weight of 1,395 kg (DIN, empty).

Aerodynamic downforce has been achieved on the new 911 GT3 through aerodynamic tuning, in particular with the aid of the new front apron including the additional outlet opening in front of the luggage compartment lid and the new rear wing.

### 1.2.3 Product description

data and availability up to the start of production.

The key details relating to the new 911 GT3 are presented on the following pages. This product description is based on the EU model and shows the changes in relation to the 911 GT3 (996). The description remains subject to changes regarding the product offering, technical

<b>911 GT3 (997)</b>	Changes in relation to the 911 GT3 (996) are shown in <b>bold</b>
<b>Product range</b>	<ul style="list-style-type: none"> <li>• 2-seater coupé</li> <li>• Available worldwide (except Taiwan and Korea)</li> </ul>
<b>1. Engine</b>	<ul style="list-style-type: none"> <li>• Water-cooled 6-cylinder naturally aspirated horizontally opposed engine; displacement 3.6 l</li> <li>• Maximum power: <b>305 kW (415 bhp) @ 7,600 rpm</b></li> <li>• Maximum torque: <b>405 Nm @ 5,500 rpm</b></li> <li>• Specific output: <b>84.7 kW/l (115.3 bhp/l)</b></li> <li>• Specific torque: <b>111.1 Nm/l</b></li> <li>• Maximum engine speed: <b>8,400 rpm</b></li> <li>• Titanium rods</li> <li>• Four-valve technology</li> <li>• VarioCam</li> <li>• Variable intake system with <b>two</b> tuning flaps</li> <li>• Dry-sump lubrication with external engine oil tank</li> <li>• <b>Optimised</b> electronic engine management system ME7.8</li> <li>• <b>Sports exhaust system with central dual tailpipe</b></li> <li>• Emissions standard – Europe: Euro 4/EOBD; USA: TIER2/LEVII, OBDII/ORVR</li> </ul>
<b>2. Transmission</b>	<ul style="list-style-type: none"> <li>• Six-speed manual gearbox with dual-mass flywheel and cable shifting</li> <li>• Transmission oil cooling via oil-water heat exchanger and oil spray lubrication</li> <li>• Steel synchroniser rings for 3rd - 5th gear</li> <li>• <b>Approx. 15% reduction in shift throw</b></li> </ul>
<b>3. Drive</b>	<ul style="list-style-type: none"> <li>• Rear-wheel drive</li> <li>• Locking differential with asymmetric locking effect (<b>28% traction, 40% overrun</b>)</li> </ul>
<b>4. Chassis</b>	<p><u>Chassis</u></p> <ul style="list-style-type: none"> <li>• <b>Porsche Active Suspension Management (PASM)</b></li> <li>• McPherson front axle with special spring and damper tuning and Uniball supporting mounts</li> <li>• Multi-link rear axle with rigidly mounted axle bracket and special spring and damper tuning</li> <li>• Vehicle lowering (approx. 30 mm in comparison to the 911 Carrera) with adapted front and rear axle kinematics</li> <li>• Adjustable chassis for use on race circuits (height, toe, camber)</li> <li>• Anti-roll bars with adapted diameter adjustable for race circuit use</li> <li>• <b>Variable steering ratio</b></li> <li>• <b>Traction Control</b> (incl. ABD/ASR and MSR); ABS</li> </ul> <p><u>Standard brake system</u></p> <ul style="list-style-type: none"> <li>• 6-piston front brake callipers, 4-piston rear brake callipers</li> <li>• Steel brake disks at front/<b>rear</b>, Ø 350/<b>350</b> mm, internally vented and cross-drilled</li> <li>• Brake callipers painted red</li> <li>• Brake lining wear indicator</li> <li>• Integrated air ducts for brake cooling</li> </ul>



<p><b>911 GT3 (1997)</b></p>	<p>Changes in relation to the 911 GT3 (1996) are shown in <b>bold</b></p>
<p><b>4. Chassis (continued)</b></p>	<p><u>Ceramic brake system PCCB (optional)</u></p> <ul style="list-style-type: none"> <li>• 6-piston front brake callipers, 4-piston rear brake callipers</li> <li>• Ceramic brake disks at <b>front/rear, Ø 380/350</b> mm, internally vented and cross-drilled with <b>enhanced disk technology</b></li> <li>• Brake callipers painted yellow</li> </ul> <p><u>Wheels and tyres</u></p> <ul style="list-style-type: none"> <li>• <b>19"</b> GT3 wheels incl. anti-theft protection and wheel hub cover with "GT3" logo</li> <li>• Front: 8.5J x <b>19</b> with tyres <b>235/35 ZR 19</b></li> <li>• Rear: <b>12J x 19</b> with tyres <b>305/30 ZR 19</b></li> <li>• <b>Wheels on rear axle with 5 mm spacers</b> (except in Japan)</li> <li>• <b>Sports tyres as standard</b></li> <li>• Tyre repair system with compressor and <b>additional air pressure tester</b></li> </ul> <p><u>Differences for USA</u></p> <ul style="list-style-type: none"> <li>• <b>Tire Pressure Monitoring standard</b> (RoW: option)</li> </ul>
<p><b>5. Body</b></p>	<ul style="list-style-type: none"> <li>• 2-seater coupé based on 911 Carrera (narrow rear) with front body-in-white section of 911 Carrera 4 (for large tank)</li> <li>• Sheet steel hot-dip galvanised on both sides</li> <li>• Omission of insulation (heavy-duty film and insulating mats)</li> <li>• <b>New front apron with additional air outlet openings in the central radiator in front of the luggage compartment lid</b></li> <li>• Rear lid with <b>new</b> fixed split wing element</li> <li>• <b>2-part ram air box on rear lid</b></li> <li>• <b>Aluminium doors</b> (as on the 911 Turbo) <b>including bow-type handles</b></li> <li>• <b>Aluminium luggage-compartment lid</b></li> <li>• Fuel tank capacity LHD <b>90 l</b>, USA and RHD <b>67 l</b></li> <li>• Reduced PVC underbody protection</li> <li>• Range of exterior colours specific to the 911 GT3</li> <li>• "GT3" logo on rear lid (black)</li> </ul> <p><u>Differences for USA</u></p> <ul style="list-style-type: none"> <li>• Fuel tank capacity <b>67 l</b> (refill capacity) including ORVR system</li> <li>• Windscreen with grey top tint – standard</li> <li>• Emergency luggage compartment release (Trunk Entrapment)</li> <li>• Rear apron with bumper horns in colour of car's exterior</li> <li>• <b>Sliding roof – standard</b></li> </ul>
<p><b>6. Interior</b></p>	<ul style="list-style-type: none"> <li>• <b>Instrument cluster</b> based on 911 with GT3 specific features similar to on Carrera GT with <b>yellow pointers and increment markings. Rev counter with titanium-coloured background, "GT3" logo and adapted red area; shift indicator</b></li> <li>• <b>Sports seats including thorax airbag worldwide – standard</b></li> <li>• <b>Optional lightweight carbon-fibre bucket seats (Carrera GT)</b> without thorax airbag with Alcantara centre section, including allocation of door panels with door pads without storage bin (USA: not available)</li> <li>• <b>3-spoke GT3 steering wheel</b> (based on 911 sports steering wheel) with GT3 specific <b>steering wheel rim in Alcantara</b> and <b>spoke trims in painted Volcano Grey finish</b>; manual length and <b>height adjustment</b></li> <li>• 3-point seat belts in Black (optional: Red, Yellow, <b>Silver Grey</b>) with belt tensioner and belt-force limiter</li> <li>• POSIP incl. driver, passenger and <b>separate head and thorax airbags</b> (in case of lightweight bucket seats option without thorax airbag)</li> <li>• Door entry guards with "GT3" logo</li> <li>• <b>911 GT3 specific gearshift lever with handle in Alcantara</b></li> <li>• Reduced scope of interior and comfort features (e.g. noise insulation)</li> <li>• Automatic air conditioning with active charcoal filter – <b>standard</b></li> <li>• Black interior equipment</li> <li>• <b>Items in painted Volcano Grey finish: Gearshift pattern trim, decorative trim on shift lever</b></li> </ul>



<p><b>911 GT3 (997)</b></p>	<p>Changes in relation to the 911 GT3 (996) are shown in <b>bold</b></p>																		
<p><b>6. Interior (continued)</b></p>	<ul style="list-style-type: none"> <li>• <b>Items in Alcantara: Seat centre sections (sports seats and bucket seats), steering wheel, shift lever, handbrake lever grip</b></li> <li>• Clubsport package (RoW: no-cost option; USA: not available) <ul style="list-style-type: none"> <li>- Bolted-on roll cage at rear</li> <li>- Preparation for battery main switch</li> <li>- 6-point belt provided for driver's side in Red</li> <li>- Fire extinguisher with holder</li> <li>- Note: <b>Clubsport package only in combination with lightweight carbon-fibre bucket seats option</b> upholstered in highly flame-retardant material</li> <li>- Note: <b>Front cage bar for FIA eligibility available as motor racing part through the motor racing department</b></li> </ul> </li> </ul> <p><u>Differences for USA</u></p> <ul style="list-style-type: none"> <li>• Sports seats <b>including passenger seat occupancy detection (USA, Canada, Mexico: Advanced Airbag)</b></li> <li>• Cruise control – standard</li> </ul>																		
<p><b>7. Electrics</b></p>	<ul style="list-style-type: none"> <li>• Modular clear-glass halogen main headlights</li> <li>• Heated windscreen washer nozzles</li> <li>• Heated rear window</li> <li>• Power windows with short-stroke lowering</li> <li>• Electrically adjustable and heated door mirrors</li> <li>• Theft protection incl. alarm system with interior surveillance</li> <li>• Weight-optimised battery (60 Ah)</li> <li>• Bi-Xenon headlights (option)</li> </ul> <p><u>Differences for USA</u></p> <ul style="list-style-type: none"> <li>• Front apron with side indicator lights in yellow</li> </ul>																		
<p><b>8. Audio and communication</b></p>	<ul style="list-style-type: none"> <li>• <b>CDR-24 radio including 4 loudspeakers</b></li> <li>• On-board computer – standard</li> </ul>																		
<p><b>9. Colours</b></p>	<p><u>Exterior colours</u></p> <ul style="list-style-type: none"> <li>• Reduced scope</li> </ul> <table border="1" data-bbox="472 1375 1505 1680"> <thead> <tr> <th>Solid colours</th> <th>Metallic colours (optional)</th> <th>Special colours (optional)</th> <th>Colours to sample</th> </tr> </thead> <tbody> <tr> <td> <ul style="list-style-type: none"> <li>• Black</li> <li>• Guards Red</li> <li>• Carrara White</li> <li>• Speed Yellow</li> </ul> </td> <td> <ul style="list-style-type: none"> <li>• Basalt Black Metallic</li> <li>• Arctic Silver Metallic</li> <li>• Midnight Blue Metallic</li> <li>• Atlas Grey Metallic</li> <li>• <b>Meteor Grey Metallic*</b></li> <li>• <b>Cobalt Blue Metallic</b></li> </ul> </td> <td> <ul style="list-style-type: none"> <li>• Slate Grey Metallic</li> <li>• <b>GT Silver Metallic</b></li> <li>• <b>Lapis Blue Metallic</b></li> <li>• Carmon Red Metallic</li> <li>• <b>Lagoon Green Metallic</b></li> <li>• Forest Green Metallic</li> <li>• <b>Dark Olive Metallic</b></li> </ul> </td> <td>Not available</td> </tr> </tbody> </table> <p>* Available from 08/2006 at the earliest</p> <p><u>Interior colours</u></p> <ul style="list-style-type: none"> <li>• Reduced scope</li> </ul> <table border="1" data-bbox="472 1812 1505 1928"> <thead> <tr> <th>Standard colours</th> <th>Leather* (optional)</th> <th>Natural leather (optional)</th> <th>Special colours, two-tone</th> </tr> </thead> <tbody> <tr> <td> <ul style="list-style-type: none"> <li>• Black</li> </ul> </td> <td> <ul style="list-style-type: none"> <li>• Black</li> </ul> </td> <td> <ul style="list-style-type: none"> <li>• Natural Dark Grey</li> </ul> </td> <td>Not available</td> </tr> </tbody> </table> <p>* incl. additional items in Alcantara: Door handle, door mirror, door storage compartment lid and centre console cover</p>			Solid colours	Metallic colours (optional)	Special colours (optional)	Colours to sample	<ul style="list-style-type: none"> <li>• Black</li> <li>• Guards Red</li> <li>• Carrara White</li> <li>• Speed Yellow</li> </ul>	<ul style="list-style-type: none"> <li>• Basalt Black Metallic</li> <li>• Arctic Silver Metallic</li> <li>• Midnight Blue Metallic</li> <li>• Atlas Grey Metallic</li> <li>• <b>Meteor Grey Metallic*</b></li> <li>• <b>Cobalt Blue Metallic</b></li> </ul>	<ul style="list-style-type: none"> <li>• Slate Grey Metallic</li> <li>• <b>GT Silver Metallic</b></li> <li>• <b>Lapis Blue Metallic</b></li> <li>• Carmon Red Metallic</li> <li>• <b>Lagoon Green Metallic</b></li> <li>• Forest Green Metallic</li> <li>• <b>Dark Olive Metallic</b></li> </ul>	Not available	Standard colours	Leather* (optional)	Natural leather (optional)	Special colours, two-tone	<ul style="list-style-type: none"> <li>• Black</li> </ul>	<ul style="list-style-type: none"> <li>• Black</li> </ul>	<ul style="list-style-type: none"> <li>• Natural Dark Grey</li> </ul>	Not available
Solid colours	Metallic colours (optional)	Special colours (optional)	Colours to sample																
<ul style="list-style-type: none"> <li>• Black</li> <li>• Guards Red</li> <li>• Carrara White</li> <li>• Speed Yellow</li> </ul>	<ul style="list-style-type: none"> <li>• Basalt Black Metallic</li> <li>• Arctic Silver Metallic</li> <li>• Midnight Blue Metallic</li> <li>• Atlas Grey Metallic</li> <li>• <b>Meteor Grey Metallic*</b></li> <li>• <b>Cobalt Blue Metallic</b></li> </ul>	<ul style="list-style-type: none"> <li>• Slate Grey Metallic</li> <li>• <b>GT Silver Metallic</b></li> <li>• <b>Lapis Blue Metallic</b></li> <li>• Carmon Red Metallic</li> <li>• <b>Lagoon Green Metallic</b></li> <li>• Forest Green Metallic</li> <li>• <b>Dark Olive Metallic</b></li> </ul>	Not available																
Standard colours	Leather* (optional)	Natural leather (optional)	Special colours, two-tone																
<ul style="list-style-type: none"> <li>• Black</li> </ul>	<ul style="list-style-type: none"> <li>• Black</li> </ul>	<ul style="list-style-type: none"> <li>• Natural Dark Grey</li> </ul>	Not available																

## 1.2.4 Product differentiation

The new 911 GT3 is to be offered as a 2-seater coupé with 6-speed manual transmission. The key differences in relation to the current 911 Carrera S are:

911 GT3 package
<p><b>Design/Body</b></p> <ul style="list-style-type: none"><li>• GT3 front apron with additional air outlet opening in the central radiator in front of the luggage compartment lid</li><li>• GT3 rear end with additional side air outlet openings and central dual tailpipes</li><li>• GT3 rear lid with fixed rear wing</li><li>• GT3 ram air box on rear lid</li><li>• 911 Carrera 4 front body-in-white section (for large fuel tank)</li><li>• Tank refill capacity 90 l</li><li>• Aluminium doors</li><li>• Reduced PVC underbody protection</li><li>• "GT3" logo on rear lid (black)</li></ul>
<p><b>Interior</b></p> <ul style="list-style-type: none"><li>• 2-seater incl. sports seats with Alcantara centre section</li><li>• 3-spoke GT3 steering wheel with steering wheel rim in Alcantara</li><li>• Gearshift lever and handbrake lever grip in Alcantara</li><li>• Steering wheel spokes, gearshift pattern trim and decorative trim on shift lever in painted Volcano Grey finish</li><li>• GT3 instrument cluster with yellow pointers and increment markings, rev counter with titanium-coloured dial</li><li>• Sill cover and rev counter with "GT3" logo</li><li>• Reduced noise insulation</li><li>• CDR-24 radio including 4 loudspeakers</li></ul>
<p><b>Engine</b></p> <ul style="list-style-type: none"><li>• Displacement 3.6 l; titanium connecting rods; forged pistons; tappets suitable for high engine speeds</li><li>• Dry-sump lubrication with external engine oil tank</li><li>• Max. output 305 kW (415 bhp) – specific output 84.7 kW/l (115.3 bhp/l)</li><li>• Max. torque 405 Nm – specific torque 111.1 Nm/l</li><li>• Max. torque 8,400 rpm</li><li>• VarioCam</li><li>• Variable intake system with 2 tuning flaps</li><li>• Sports exhaust system with central dual tailpipes</li><li>• Battery 60 Ah</li></ul>
<p><b>Transmission</b></p> <ul style="list-style-type: none"><li>• 6-speed manual transmission with short transmission ratios, transmission oil cooling and steel synchroniser rings in 3rd to 5th gear</li><li>• Locking differential with asymmetric locking effect</li><li>• Traction Control (incl. ABD/ASR and MSR)</li></ul>
<p><b>Chassis</b></p> <ul style="list-style-type: none"><li>• GT3 specific tuning for Porsche Active Suspension Management (PASM)</li><li>• Chassis adjustable (height, camber and toe) and lowered by approx. 30 mm in comparison to the 911 Carrera</li><li>• Uniball supporting mounts on front axle</li><li>• Rear axle with rigidly mounted axle bracket</li><li>• Front axle brake system with 6-piston aluminium fixed callipers and brake disk diameter of 350 mm</li><li>• 19" GT3 wheels incl. wheel hub cover with "GT3" logo</li><li>• Sports tyres</li></ul>
<p><b>Options</b></p> <ul style="list-style-type: none"><li>• Restricted scope</li></ul>

## 2 Engine

The engine of the new 911 GT3 has been developed on the basis of the 911 GT3 (1996) featuring the familiar 6-cylinder horizontally opposed engine with a displacement of 3.6 l, which was originally based on the engine from the 911 GT1. This excellent mechanical basis, which has proven its worth over several evolutionary milestones in the racing engines of the 911 GT3 Cup, 911 GT3 RS and 911 GT3 RSR, has been found to possess adequate potential for further development.

The particularly exacting development remit was to achieve a further improvement on the outstanding specific output offered by the engine in the 911 GT3 (1996). This has been accomplished by applying state-of-the-art technologies, fine-tuning all components affecting power output and using materials from the field of motor racing. A special focus was on further increasing the maximum power output in conjunction with a higher torque curve throughout the entire rev range.

The improvements over the 1996 GT3 (1996) have been achieved primarily by means of the following measures:

- Redesign of the entire gas cycle (including variable induction system with two tuning flaps and sports exhaust system)
- Enhanced high engine speed concept



fig. 12: Engine

### Specific output

Along with the maximum output, the specific output also provides a quantitative and qualitative power characteristic indicating an engine's development level and thus providing a measure of its power-related efficiency.

On the basis of a displacement volume of 1 litre, the specific output indicates how effectively the power-determining parts of an engine's mechanical system (crank drive and valve drive) and the thermodynamic system (intake and exhaust systems, valve control system) have been developed and tuned. The mechanics determine the maximum possible engine speed, while the thermodynamics define the gas cycle, or "aspiration" of the engine.

The 1996 GT3 (1996) had a specific output of 77.8 kW/l, or 105.8 bhp/l. As a result of extensive modification of the gas cycle and the enhanced high engine speed concept, the engine on the new 911 GT3 achieves an impressive specific output of 84.7 kW/l, or 115.3 bhp/l. This value makes the engine a front-runner among the natu-

rally aspirated engines in today's sports car segment, and is surpassed in only a small number of cases worldwide.

### High engine speed concept

In order to increase an engine's maximum output, in addition to improving the gas cycle it is also necessary to raise the maximum engine speed. The specific stress imposed on the components concerned must be reduced in order to ensure the necessary high revving stability. Reducing the moving masses of the valve and crank drive plays a particularly vital role here.

The valve drive was initially redesigned for the high engine speed concept on the 1996 GT3 (1996), involving maximum engine speeds of up to 8,200 rpm. The main focus in measures to reduce the moving masses was on lighter valves and small, lightweight GT3-specific tappets.

The further increase in maximum output on the new 911 GT3 to as high as 8,400 rpm necessitated a redesign of the crank drive. In order to reduce the moving masses and to lower the level of

stress imposed on the relevant components, the pistons, including the pins, the connecting rods and the crankshaft have been redesigned. 8,400 revs per minute is an absolutely exceptional value for road-licensed standard production vehicles and places the new 911 GT3 among the front runners in the sports car segment.

In order to make optimum use of the high maximum engine speed and to enable ideal timing of gear-shifting when accelerating, the new 911 GT3 features a shift indicator in the instrument cluster for the first time. Further information on the shift indicator is to be found in section 7.3 – Electrics/instruments.

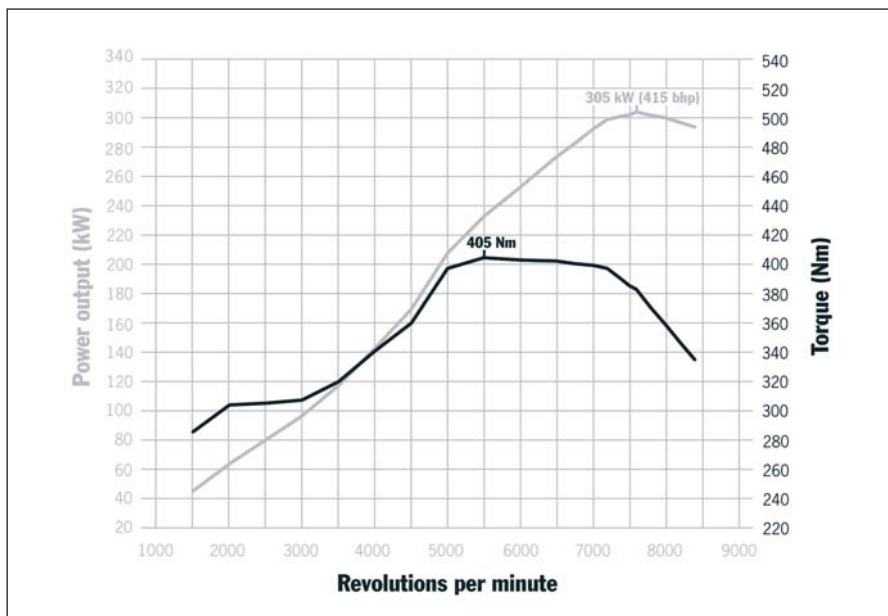

Fig. 13: Power and torque curve

Technical data	New 911 GT3 (997)	911 GT3 (996)
Max. output	<b>305 kW (415 bhp) at 7,600 rpm</b>	280 kW (381 bhp) at 7,300 rpm
Maximum torque	<b>405 Nm at 5,500 rpm</b>	380 Nm at 5,000 rpm
Specific output	<b>84.7 kW/l (115.3 bhp/l)</b>	77.8 kW/l (105.8 bhp/l)
Specific torque	<b>111.1 Nm/l</b>	105.6 Nm/l

Apart from the high power and torque values of the extremely compact engine, the new 911 GT3 impresses in particular by virtue of its vast revving capability and excellent response throughout the entire rev range. These characteristics ensure a very sporty driving experience in all driving conditions.

In addition to its outstanding performance capabilities, the new 911 GT3 also complies with all laws on noise and exhaust emissions worldwide (except in Korea and Taiwan).

### SPORT functions

Pressing the “SPORT” button on the centre console of the new 911 GT3 increases the engine’s torque in the mid rev range by up to 25 Nm and selects a sporty tuning option for Traction Control (see Chassis section).

In Sport setting, the exhaust backpressure in the variable exhaust system is additionally reduced and the gas cycle is improved, resulting in a noticeable boost in torque in the rev range between approx. 3,000 and 4,200 rpm. The torque levels are increased by between approx. 20 and 25 Nm. The maximum level of 405 Nm at 5,500 rpm remains unchanged.

### Main technical features

- 3.6 l displacement
- 4 valves per cylinder
- Water cooling
- Vertically split crankcase made of die-cast light alloy
- Cylinder housing separate from crankcase
- Crankshaft running on eight bearing points
- Titanium connecting rods
- Forged pistons
- Dry-sump lubrication with external engine oil tank
- Continuous adjustment of the intake camshafts (VarioCam)
- Tappets designed to cope with high engine speeds, with crowned contact surface and hydraulic valve clearance compensation
- Variable induction system with two tuning flaps

- Static high-voltage ignition system with individual ignition coils
- Sports exhaust system with one catalytic converter located close to the engine, 2 front silencers and one rear silencer per exhaust tract, with central dual tailpipes.
- Stereo lambda control with one lambda probe up- and down-line of the catalytic converter in each exhaust tract (lambda probe only up-line of the catalytic converter in countries with leaded fuel)
- On-Board Diagnostics for worldwide use

Key changes on the new 911 GT3	New 911 GT3 (997)	911 GT3 (996)	Improvement
Component			
Upper part of air cleaner	Additional flow optimisation	Flow-optimised	Gas cycle (including cylinder charging)
Throttle	ø 82 mm	ø 76 mm	
Induction system	Variable induction system with two tuning flaps and revised intake pipe fittings	Variable induction system with one tuning flap	
Intake pipe	ø 48 mm	ø 45 mm	
Manifold	High-performance manifold	Standard manifold	
Exhaust system	Sports exhaust system featuring further reduction in flow resistance	Standard exhaust system with reduced flow resistance	
VarioCam	Continuous vane adjuster (adjustment range 52 ° relative to crankshaft)	Axial camshaft adjuster (adjustment range 45 ° relative to crankshaft)	
Camshaft	Intake valve lift 12.7 mm	Intake valve lift 12.3 mm	High engine speed concept
Pistons	Lightweight design featuring additional weight reduction (approx. 6 %)	Lightweight design	
Connecting rods	Titanium connecting rods 131 mm	Titanium connecting rods 130 mm	
Crankshaft	Lightweight design featuring further reduction in weight	Lightweight design	
Compression ratio	12.0:1	11.7:1	Combustion
Positioning of catalytic converters	Directly down-line of the manifolds	In transverse position down-line of the engine	Reduced emissions



Fig. 14: Cross-section through the engine

## 2.1 Basic engine

As on the 911 GT3 (1996), the engine of the new 911 GT3 also features a vertically split light-alloy crankcase. This crankcase was originally used on the 911 GT1 and is also employed in the racing versions of the 911 GT3.

The crankshaft running on eight bearings also originates from the 911 GT1 and 911 GT3 (1996). In order to enable a further optimisation of the high engine speed concept on the new 911 GT3, the crankshaft weight has been cut by approx. 700 g in comparison to the 911 GT3 (1996).

The length of the titanium connecting rods which were used in the 911 GT3 (1996) has also been increased by 1 mm to 131 mm in the interest of an increased maximum engine speed. This promotes the transfer of forces from the connecting rod to the crankshaft and reduces the stress on the relevant components. All connecting rods on the 911 GT3 are made of titanium, in order to ensure that the components retain the required stability throughout their service lives at the high engine speeds (8,400 rpm) and to provide the necessary speed reserves (up to over 9,500 rpm) as the basis for racing engines. The weight reduction over a comparable steel connecting rod stands at approx. 150 g per rod, or approx. 26 %.

The forged pistons and piston pins of the 911 GT3 (1996) have also been redesigned to realise the further enhanced high speed concept for the new 911 GT3. The form of the pistons has been modified and the piston pin diameter has been reduced by 1 mm to 21 mm. This results in total weight savings on the new 911 GT3 of approx. 30 g or 6 % per piston, including piston pin. In order to improve combustion, the piston head has also been redesigned as part of the combustion chamber shape on the new 911 GT3.

As on the 911 GT3 (1996), the oil supply on the new 911 GT3 also takes the form of a classic dry sump lubrication system with separate oil tank. With this system, the oil pump is also driven by the crankshaft, via the intermediate shaft and connecting shaft. The oil pump itself consists of three segments, whereby one pump segment is responsible for pressure oil feed to the engine. This segment draws in the engine oil from the separate oil tank via an oil/water heat exchanger and the oil filter and subsequently feeds it into the engine oil circuit. The two other pump segments extract the oil which accumulates in the crankcase and pump it back into the separate oil tank.



A dual oil extraction pump is installed on the output side of each exhaust camshaft. This extraction pump ensures the fastest possible return of engine oil from the front and rear of the cylinder heads, even at high levels of lateral and longitudinal acceleration. Similarly to the 911 GT3 (1996), the new 911 GT3 thus also possesses a total of 7 oil pumps (1 oil pressure pump in the crankcase, 2 oil extraction pumps in the crankcase and 4 oil extraction pumps in the cylinder heads).

As on the 911 GT3 (1996), the short block engine on the new 911 GT3 also features a “sandwich” design. This means that the cylinder housing, cylinder head and camshaft housing for each cylinder bank are individual components which are bolted to the crankcase. The light-alloy cylinder housings are made of aluminium and possess separate cylinder liners which are coated with Nikasil.

The cylinder heads are produced in an extremely temperature-stable light alloy and are provided with additional cooling of the exhaust valve rings on the new 911 GT3. As on the 911 GT3 (1996), the intake and exhaust ports have been machined to improve flow conditions and, in turn, the gas cycle and output. For more efficient combustion and attendant reductions in fuel consumption, the compression ratio has been increased from 11.7:1 on the 911 GT3 (1996) to 12.0:1 on the new 911 GT3.

The intake valves of 41 mm in diameter and the exhaust valves with a diameter of 35.5 mm have been adopted from the 911 GT3 (1996). They are arranged in a V shape with a valve angle of 27.4° and possess a valve stem diameter of 6 mm to reduce the moving masses of the valve drive.

In order to ensure correct closing of the valves in accordance with the power-oriented timing and the high engine speed concept, double valve springs have been used on the intake and exhaust valves of the new 911 GT3, too. The small, light-weight tappets with hydraulic valve clearance compensation have also been adopted from the 911 GT3 (1996).

As on the 911 GT3 (1996), the intake valves on the new 911 GT3 are also controlled by means of VarioCam. The method of angle adjustment has been altered. On the 911 GT3 (1996), this was carried out by means of an axial camshaft adjuster with two switching positions. On the new 911 GT3, angle adjustment is carried out continuously via a vane adjuster. This method was first applied in the 911 Carrera (1996) models in model year 2002 and is also employed in the current 911 Carrera models. This modification has enabled an increase in the adjustment range for the intake camshaft from 45° on the 911 GT3 (1996) to 52° on the new 911 GT3. This results in further improved engine characteristics with regard to output, torque and exhaust behaviour.

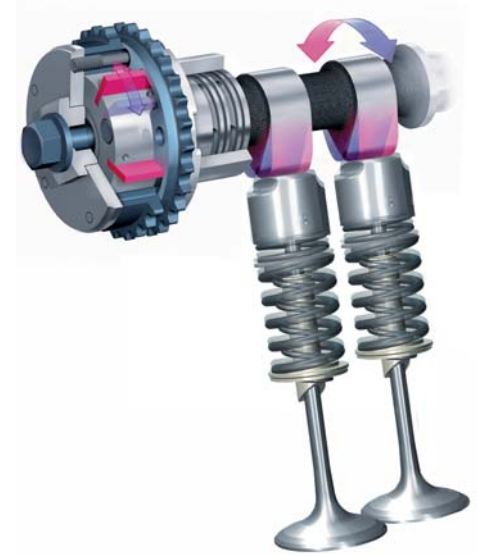

Fig. 15: VarioCam

The basic design of the camshafts has been adopted from the 911 GT3 (1996). Due to the higher power requirements, the intake cams have been modified and the lift of the intake valves has been increased from 12.3 mm on the 911 GT3 (1996) to 12.7 mm. The cam shape and the 11.1 mm lift of the exhaust valves have been adopted from the 911 GT3 (1996).



Fig. 16: Resonance induction system

## 2.2 Induction system

The engine on the new 911 GT3 is supplied with air directly via the air box of the ram air system on the rear lid. The ram air system consists of two ram air boxes which are mounted on the rear lid. They use the air flowing over the vehicle and improve both the supply of cooling air to the engine compartment (left air box) and the intake of combustion air for the engine (right air box).

The air cleaner housing has been adopted from the 911 GT3 (996) and optimised, featuring an enlarged cross-section in the outlet to the throttle valve in comparison to the air cleaner housing on the 911 GT3 (996). As a result of this measure and the increase in the diameter of the throttle valve from 76 mm on the 911 GT3 (996) to 82 mm, flow resistance is reduced and the gas cycle is improved.

After passing through the air cleaner, the hot film air flow sensor and the throttle valve, the air flows into a new aluminium variable induction system with two switchable tuning flaps. This resonance induction system featuring an additional flap in comparison to the 911 GT3 (996) plays a major role in enabling the high power and torque values of the new 911 GT3. The new resonance induction system essentially comprises 2 plenum chambers (on the right and left above the cylinders), 3 connecting pipes (one distributor pipe and two connecting pipes with tuning flaps) and individual intake pipes for the cylinders.

A flow-promoting induction system with smooth surfaces and large cross-sections is necessary for good charging of the cylinders and resultant high output values. The plenum chambers and intake pipes on the new 911 GT3 have thus been generously dimensioned and their interiors have been designed and finished with due meticulous care. In addition to the flow characteristics, intensive utilisation of the air resonance pulsating in the induction system is also necessary to ensure good charging of the cylinders. This is carried out via the

switchable connecting pipes with tuning flaps, which are controlled via the Motronic system.

The opening and closing of the valves and the movements of the pistons cause the air in the intake system (and in the induction system in particular) to oscillate. The intensity of oscillation is dependent on the engine speed (which incites the oscillation) and the self-resonance of the intake system. Within a limited rev range, this oscillatory system begins to resonate, enabling high levels of air oscillation. These oscillations are used to ensure optimum charging of the cylinders with air, resulting in high torque and output values. Varying engine speeds result in corresponding variations in the oscillatory effect. In order to instil a resonant state in the system once again, the self-resonance of the induction system must be altered. This is achieved by opening and closing the tuning flaps in the connecting pipes on the induction system.

In order to utilise the resonance effect over a broad rev range, a multi-stage induction system incorporating several tuning flaps is required. An induction system with two tuning flaps has been selected for the new 911 GT3, with due regard to the required rev range, the thermodynamically effective resonance width of the oscillations, the required pipe cross-sections and the given space conditions.

For the purposes of a uniform and high torque curve, the following actuating strategy has been chosen for the tuning flaps on the new 911 GT3: At low and medium engine speeds, the tuning flaps are closed. From a speed of approx. 5,400 rpm, the thin connecting pipe is opened by means of the first tuning flap. At approx. 6,350 rpm the thin connecting pipe is closed and the thick connecting pipe is opened by means of the second tuning flap. These measures enable not only a high torque curve over a large rev range and high maximum torque, but also a high maximum output.

### 2.3 Exhaust system

The sports exhaust system of the new 911 GT3 is totally new. The system comprises of high-performance manifolds, 2 catalytic converters located close to the engine, 2 front silencers fitted at the sides and one common rear silencer with central twin tailpipes. In conjunction with the other power-enhancing measures, this system enables the new 911 GT3 to achieve the intended high specific engine output with an extremely low level of exhaust backpressure.

In comparison to the standard manifolds on the 911 GT3 (996), the new high-performance manifolds offer both reduced flow resistance and enhanced mixing, thus improving pre-conditioning the raw emissions before they are subsequently converted in the catalytic converter.

On the 911 GT3 (996) the catalytic converters are installed in transverse position under the rear end. On the new 911 GT3, the catalytic converters are located at the sides directly behind the manifolds. This position close to the

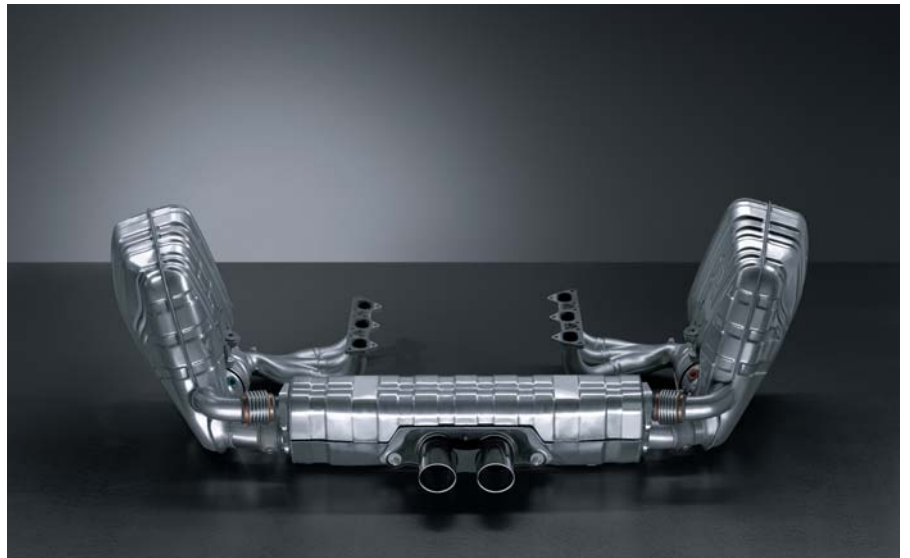

Fig. 17: Sports exhaust system

engine enables faster heating-up and response of the catalytic converters, resulting in reduced exhaust emissions, particularly after cold starting.

The silencer system on the new 911 GT3 is also a completely new development. The 911 GT3 (996) made do with only two silencers at the sides in the rear wings. The new 911 GT3 possesses two front silencers in this position which can be activated and deactivated via map control and an additional rear silencer located under the rear end.

The front silencers are activated and deactivated via vacuum-controlled exhaust flaps located on the right and left down-line of the catalytic converters, between the front silencer and the rear silencer. When these flaps are closed, the exhaust gas is directed exclusively via the front silencers to the main silencer. When the exhaust flaps open, this provides a direct passage to the main silencer, resulting in a reduction in exhaust backpressure of approx. 8 % in comparison to the 911 GT3 (996) and a further increase in engine output. The exhaust flaps are controlled according to the prevailing loads and speeds.

### Exhaust gas

Similarly to the 911 GT3 (996) before it, the new 911 GT3 also meets the requirements of the Euro 4 exhaust emissions standard that applies in Europe, despite the further increase in power and torque. A new development is compliance with the LEV II exhaust emissions standard ("Low Emission Vehicle") which is statutory in the USA. LEV II requires a 75 % reduction in NOx in comparison to the original LEV exhaust emission standard (911 GT3 /996).

The new 911 GT3 complies with the more stringent emission limits in particular by virtue of the relocation of the catalytic converter closer to the engine. As a result of its position directly down-line of the exhaust manifold, the catalytic converter is heated up more swiftly and the exhaust gases are converted more quickly.



Fig. 18: The new 911 GT3

## 2.4 Engine management

Similarly to the current 911 Carrera generations, the new 911 GT3 also features the optimised Motronic ME 7.8 engine control system. The new Motronic version offers increased computing capacity and a higher memory capacity in comparison to the familiar ME 7.8 version from the 911 GT3 (996). These enhancements are required above all in order to handle the extended diagnostic functions.

The new 911 GT3 also features the On-Board Diagnosis system (OBD → USA) or the European On-Board Diagnostics system (EOBD → Europe/RoW) which is familiar from the 911 GT3 (996). This system is designed to warn drivers anywhere in the world, via an appropriate signal in the instrument cluster, of any emission- or engine-related faults. Each system is fully compliant with all national legislation.

In addition to the extended OBD functions, the optimised ME 7.8 on the new 911 GT3 also processes and controls the tuning flaps of the induction system, the exhaust flaps on the sports exhaust system and the variable control system for the radiator fan in the front apron.

## 3 Power transmission

### 3.1 Transmission

Similarly to the 911 GT3 (996), the new 911 GT3 is also fitted exclusively with a manual 6-speed transmission. The transmission itself originates from the 911 GT3 (996) and has also been used in the 911 GT2 (996) and the 911 GT3 CUP (996) and 911 GT3 RSR (996) racing cars. The essence of this transmission is also installed in the current 911 GT3 CUP (997) racing cars.

In order to improve acceleration and to adapt the transmission to the torque curve of the new 911 GT3, the gear ratios for 2nd to 6th gears have been reduced. This has been made possible by the further enhanced high engine speed concept, and offers an additional improvement in power transmission when accelerating after changing gear by means of a higher maximum and shifting speed.

In the interest of high shifting dynamics with short shift throws, the new 911 GT3 is fitted with the shift console from the current 911 Carrera generations, featuring a short shift lever ratio and a GT3-specific short lever ratio on the transmission input lever. This makes the overall shifting ratio on the new 911 GT3 approx. 15 % shorter than on the 911 GT3 (996) and approx. 22 % shorter than on the current 911 generation.

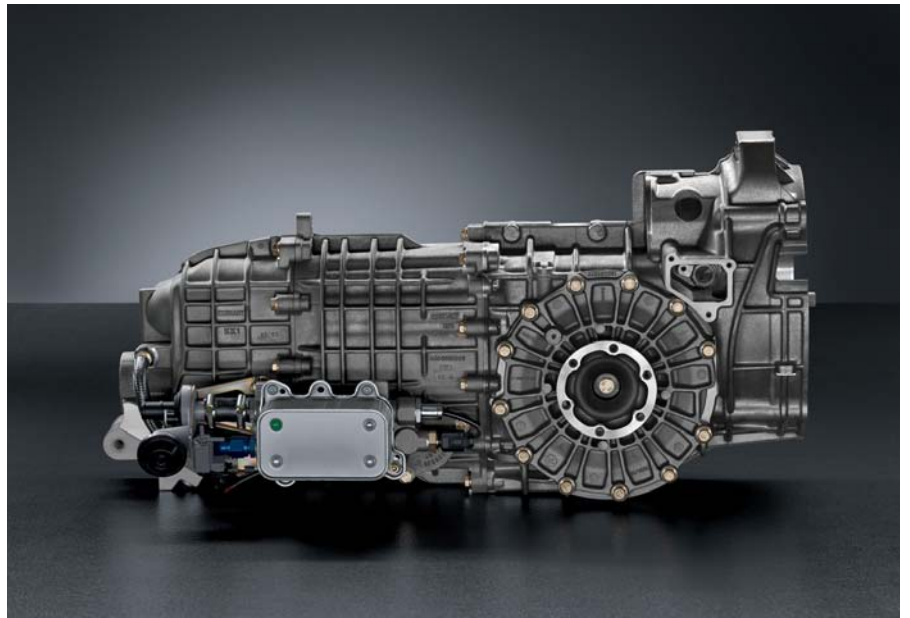

Fig. 19: Transmission

#### Key features:

- Cable shifting with direct shifting action via a short transmission ratio on the transmission input lever
- Oil spray lubrication with pressure oil feed via oil pump
- Transmission oil cooling via transmission oil/water heat exchanger to ensure adequate durability even under extreme loads
- Steel synchronisation rings for 3rd to 5th gears for more exact gear-changing under extreme loads
- Adjustable transmission ratios via exchangeable gearwheels (exclusively for use on the race track)
- Shorter transmission ratios for 2nd to 6th gears in comparison to the 911 GT3 (996)
- Dual mass flywheel
- Clutch operation without power assistance
- Components designed with high reserves of stability for use on transmissions in vehicles with high power requirements

### 3.2 Locking differential

Similarly to the 911 GT3 (996), the new 911 GT3 also comes with an asymmetric locking differential as standard. The locking values are 28% (traction) and 40% (overrun). These values have been changed slightly in comparison to the previous model (40% traction, 60% overrun) and adapted to the specific handling of the new 911 GT3 with improved driving dynamics.

The asymmetric locking values have been designed and tuned according due consideration to the vehicle's specific design and driving characteristics, such as weight distribution, traction requirements, engine drag torque and driving stability, including load changing and cornering behaviour. The gearwheels of the locking differential have also been strengthened, on account of the higher output values of the new 911 GT3 and the attendant increased requirements regarding component stability.





Fig. 20: Technical overview

## 4 Chassis

The new 911 GT3 comes with a chassis featuring actively adjustable dampers as standard for the first time. The Porsche Active Suspension Management system (PASM) which is familiar from the current 911 Carrera generation has been adapted to the specific requirements of the new 911 GT3. Due consideration has been accorded here to the car's characteristic features, such as extremely sporty performance with superior handling – also on the race track – and a high level of driving safety.

### Main features

- Lowering by approx. 30 mm (in comparison to the 911 Carrera), accompanied by a corresponding lowering of the vehicle's centre of gravity
- Variable damper system Porsche Active Suspension Management (PASM)
- Traction Control (TC) vehicle stabilisation system

- Adjustable anti-roll bars at front (five settings) and rear (three settings) for adaptation to individually desired handling characteristics \*
- Spring system compatible with racing springs to enable adaptation to different race track characteristics \*
- Axle geometry adjustment range to accommodate the use of racing tyres and the attendant specific requirements (e.g. camber adjustment) \*
- Reinforcement of relevant components (e.g. pivot bearings and front wheel bearings) for the possible use of racing tyres\* and the associated higher load on individual components (especially on front axle)
- Optimisation of wheel guidance (especially on rear axle)
- Variable steering ratio (corresponding to the new 911 generation)
- Reinforced brake system
- Porsche Ceramic Composite Brake (option) with larger brake disc on the front axle

- Sports tyres as standard
- Tire Pressure Monitoring optional (standard for NAFTA)

### \*Note:

These modifications are only permissible in off-road use, as they have a very pronounced effect on the vehicle's handling characteristics. The mutual interactions are to be considered when changing chassis settings and/or chassis components.



#### 4.1 Porsche Active Suspension Management (PASM)

The PASM variable damping system which is familiar from the current 911 Carrera generation features on the new 911 GT3 as standard with special tuning to meet the more stringent requirements regarding driving dynamics.

Similarly to on the current 911 Carrera models, PASM on the new 911 GT3 also features two characteristic fields, but with different tuning and programme definitions:

On the new 911 GT3, PASM once again combines two chassis in one. In contrast to on the 911 Carrera models, however, Normal mode is employed not for a higher level of comfort, but rather to offer the sportiness and agility which is familiar from the 911 GT3's predecessor models, without neglecting the comfort which is required in everyday use. On the new 911 GT3, this setting is sufficient to ensure high driving dynamics on public roads and race tracks with varying and uneven surfaces (e.g. the Nordschleife of the Nürburgring). In order to further enhance the 911 GT3's dynamic

potential on smooth-surfaced race tracks in particular, in Sport mode PASM minimises body movements to offer particularly precise and direct performance. The design and mode of functioning of the PASM system correspond to the functions and actuating strategies which are familiar from the current 911 Carrera models.

Programme		New 911 GT3 (997)	911 Carrera models (997)
Normal mode	PASM button not pressed	<u>Sporty and rigid</u> set-up for public roads and race circuits with uneven surfaces (e.g. Nordschleife of the Nürburgring)	<u>Sporty and comfortable</u> set-up for enhanced comfort
Sport mode	PASM button depressed*	<u>Uncompromisingly sporty</u> set-up for particularly high driving dynamics and reduced body movements, especially for smooth race circuits	<u>Sporty and rigid</u> set-up for enhanced driving dynamics

\* including "PASM Sport" on the display of the instrument cluster

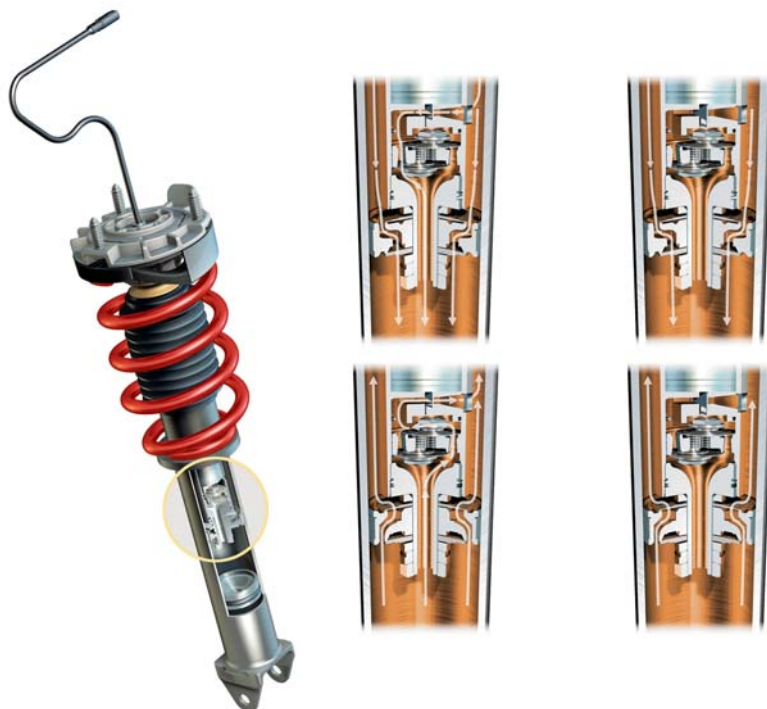

Fig. 21: PASM

## 4.2 Traction Control/ABS

In “Traction Control” (TC), the new 911 GT3 is provided for the first time with a system to promote driving stability during acceleration. This system comes as standard and is used in a similar manner on the Carrera GT. It incorporates the following features:

- ABD (automatic brake differential)
- ASR (anti-slip regulation) including MSR (engine drag torque control)

In conjunction with the familiar anti-lock brake system (ABS) and the Traction Control (TC) system tuned specifically for the new 911 GT3, the latter now possesses a system to promote driving stability during both braking and accelerating. TC supports straight-line stability and overall driving stability in particular in adverse weather conditions such as rain or when varying levels of grip apply on the road surface.

### Mode of functioning of the Traction Control system

When drive wheels begin to spin, the automatic brake differential function (ABD) first of all brakes the wheel with a higher level of slip. If both wheels are spinning, ASR will intervene within fractions of a second.

The purpose of the anti-slip regulation (ASR) function is to prevent excess wheel slip on the drive wheels in order to increase cornering traction at the rear axle. The ASR function is activated when accelerating across the entire speed range. As a result of intervention in the engine control system, the engine power is decreased via a reduction in torque, acceleration and ignition angle. When ASR is activated, the relevant information light lights up on the instrument cluster. This yellow information light displays a warning triangle to indicate that the adhesion limit has been reached.

Engine drag torque control (MSR) is a function within ASR. This function takes effect, for example, when there is a risk of a loss of lateral stability at the rear axle after a downshift on a slippery surface due to rear wheels locking as a result of engine drag torque. In such a situation, MSR can quickly open the throttle by demanding more power from the engine management system, thereby restoring driving stability.

### SPORT / TC OFF

To enable the car’s driving dynamics to be increased according to individual needs, the standard “SPORT” button for Traction Control on the centre console enables a sporty set-up with delayed intervention by the ABD, ASR and MSR functions or, alternatively, the entire system can be switched off via the “TC OFF” button. “TC OFF” appears on the instrument cluster display when the system is switched off.

Overview of customer benefits offered by Traction Control

- Optimum traction and straight-line stability when accelerating even on surfaces with varying levels of grip (e.g. road surfaces)
- Reduction of braking distances with improved directional stability during braking, particularly in bends and on surfaces with varying levels of grip
- Sports-oriented set-up offering remarkable driving safety whilst retaining outstanding agility and superior handling characteristics, even when exploiting the car’s performance to the full
- Sport setting and option to disable the Traction Control function if driver wishes to increase driving dynamics manually

Apart from influencing the car’s driving dynamics, pressing the “SPORT” button also raises the engine’s torque characteristics in the mid-rev range. Please refer to the Engine section for further information.

### 4.3 Front axle

The basis for the new 911 GT3 is provided by the tried and tested front axle concept from the 911 GT3 RS (996). Basically, the axle has been adapted to the higher performance potential by means of stiffer springs, dampers and anti-roll bars.

A new feature is the damper strut for Porsche Active Suspension Management (PASM). Specifically for the 911 GT3, this strut is additionally provided with an external thread and a height-adjustable retainer. As on the 911 GT3 (996), in addition to lowering the vehicle's height, this also enables fine adjustment of the individual wheel loads when necessary. The compression and rebound stage of the single-tube gas-filled damper is sportier than on the 911 Carrera models. The new 911 GT3 again features cylindrical springs with a linear characteristic on the front axle. These springs are positioned axially to the damper strut. The geometric designs of the springs and spring plates are based on racing spring standards, in order to enable modified chassis set-ups to be realised with a relatively small scope of work for motor racing use on closed circuits.

In order to obtain precision attachment of dampers and piston rods so as to minimise effects on axle kinematics during compression, the supporting mounts are provided with a Unibal joint, as on the 911 GT3 (996). The supporting mount is designed for two possible mounting positions so that different camber ranges can be set for road or racing tyres with very little effort.

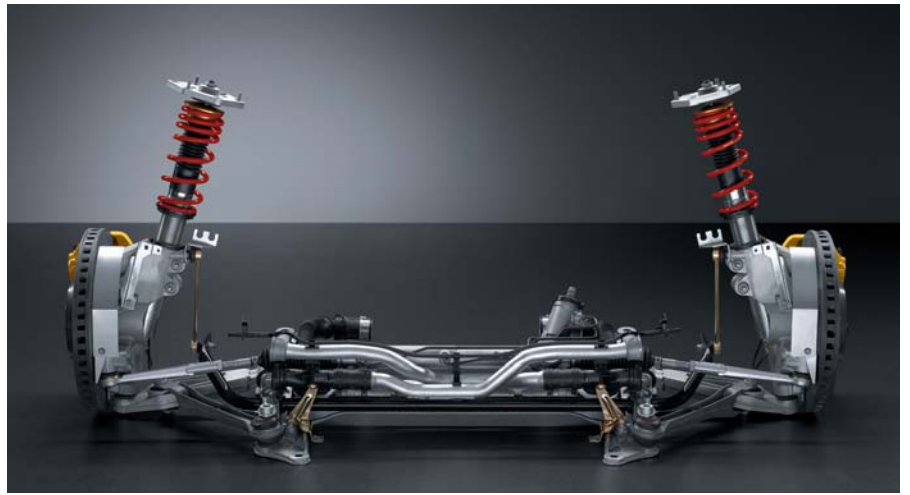

Fig. 22: Front axle

As on the 911 GT3 (996), fine camber adjustment is carried out by adjusting shims on the lower split wishbone. This method of adjustment at the wishbone has the advantage that a small increase in track width is also obtained with the larger camber. In order to ensure optimum axial geometry at all times despite this broad camber adjustment range, the wishbone incorporates two attachment points for the trailing links.

The pivot bearing on the new 911 GT3 corresponds to that on the 911 GT3 (996), with a wheel bearing diameter of 80 mm, and attachment of the dampers with a double-brace bracket corresponds to the 911 GT3 RS (996). This configuration results in load reserves when using racing tyres. The coupling of the tie rods has been adapted to neutralise the influence on the overall axle geometry as a result of the approx. 30 mm lowering of the vehicle in comparison to the 911 Carrera.

Similarly to the 911 GT3 (996), the new 911 GT3 also possesses a tubular anti-roll bar with five adjustable settings on the front axle, featuring a more rigid set-up than the current 911 Carrera generation. Adjustment is carried out in the familiar manner via different screw-on points for the anti-roll bar bracket on the push rod between anti-roll bar and wheel carrier. Adjustment affects the lever arm of the anti-roll bar and, in turn, the supporting force for compression at the wheel of an axle opposite a more strongly compressed wheel. The anti-roll bars can be adjusted to fine-tune the chassis to personal requirements. The anti-roll bar suspension has also been redesigned in order to reduce the influence of steering actions on the anti-roll bar.

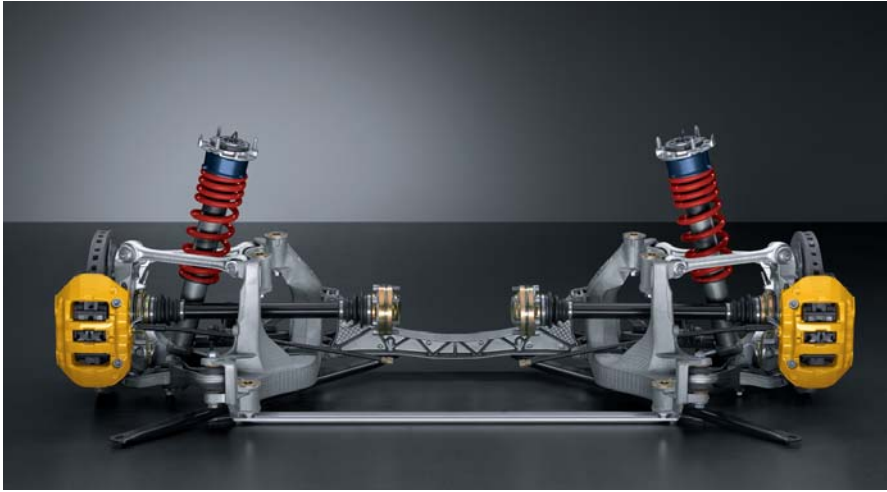

Fig. 23: Rear axle

#### 4.4 Rear axle

The essential design of the rear axle on the new 911 GT3 corresponds to that on the current 911 Carrera. The rear axle has also been adapted to the higher performance potential by means of stiffer springs, dampers and anti-roll bars. The tubular anti-roll bar can be adjusted to 3 settings (911 GT3/996: 4 settings). The anti-roll bar on the rear axle can also be adjusted on the new 911 GT3 to fine-tune the chassis to personal requirements.

The rear axle has been revised at several points in order to meet the special requirements pertaining to the 911 GT3, including motor racing use.

In order to achieve more rigid connection of the side members to the body, the rubber mountings employed on the 911 Carrera have been replaced by metal bushings on the new 911 GT3, as on the 911 GT3 (996). In addition to more rigid connection of the rear axle, this measure also enables the attachment points to be positioned 6 mm higher. This results in improved kinematics, accompanied by reduced changes to camber and track during compression. The wishbones and wheel carriers

have been adopted from the current 911 Carrera.

As on the front axle, the damper strut with PASM on the rear axle also incorporates an additional external thread and a height-adjustable retainer. As on the front axle, here too the compression and rebound stage of the single-tube gas-filled damper is sportier than on the 911 Carrera models. The springs on the rear axle are also cylindrical, arranged axially to the damper strut axis, and have a progressive characteristic. The upper retainer is made of aluminium and is installed on a rigid mounting.

The supporting mounts correspond to those on the current 911 Carrera with sports chassis, with a piston rod attachment installed in rubber mounting for optimised comfort. Due provision has been made for retrofitting of the supporting mounts from the 911 GT3 Cup with rigid piston rod mounts for racing purposes, however.

#### 4.5 Steering

The steering system on the new 911 GT3 has been adopted from the current 911 Carrera generation.

Changes in relation to the 911 GT3 (996):

- Variable steering ratio
- Additional height adjustment of the steering wheel
- Electric steering wheel lock
- Longer tie rods

The established advantages of the variable steering ratio are increased agility, particularly on winding stretches of road, combined with driving stability at very high speeds. This is achieved by using the familiar steering ratio around the straight-ahead position with small movements of the steering wheel. As a result the vehicle remains very smooth, particularly at high speeds, and does not react skittishly if the driver unintentionally turns too acutely to avoid something on the road.

The steering ratio becomes increasingly more direct with steering wheel movements of more than approx. 30° (up to 13.8:1 for a steering wheel revolution of more than three-quarters). The steering wheel revolutions from stop to stop have thus been reduced from 2.98 on the 911 GT3 (996) to 2.62 on the new model. This results in significantly greater agility when driving on winding roads and particularly in tight corners. It also improves handling when turning in city traffic. In this case, the steering response is much more spontaneous. Parking is also easier since the greater the steering wheel angle relative to the steering, the harder the wheels turn. The turning circle of 10.9 m is also on a par

with the 10.6 m of the 911 GT3 (996), despite the larger wheels.

A further improvement is the facility for manual height adjustment of the steering wheel. In addition to the familiar 40 mm reach adjustment range, the steering wheel in the new 911 GT3 is now also height-adjustable by 40 mm, as on the current 911 Carrera generation. This enables further personalisation of the ideal sitting and steering wheel position, also improving the driver's view of the instruments.

The steering wheel lock on the new 911 GT3 has been switched from a mechanical to an electrical system, as on the current 911 Carrera generation. It is a component in the networked immobiliser system, offering in particular increased anti-theft protection.

## 4.6 Brake system

### Standard brake system

The standard brake system with steel brake discs on the new 911 GT3 has been developed on the basis of the 911 GT3 (996), using components from the new 911 Turbo (997) and Carrera GT.

On the front axle the brake discs from the 911 GT3 (996) have been adopted and combined with the 6-piston brake callipers from the rear axle of the Carrera GT. The brake ventilation system has been improved for enhanced cooling of the brakes on the front axle via the use of new brake air deflectors and new air deflection blades. The air deflection blades guide the majority of the air flow which is discharged through the wheel house liners behind the radiators directly to the brake system. In order to reduce the transmission of high brake tempera-

tures to the hydraulic fluid, the pistons of the brake callipers are thermally isolated by means of ceramic inserts, thus protecting the brake fluid from overheating even when extreme thermal loads apply. On the rear axle, the entire brake system including brake ventilation has been adopted from the new 911 Turbo (997).

The distribution of brake power between the front and rear axle has been reconfigured on the new 911 GT3. The rear axle receives a higher level of brake power. This redistribution is based on experience from motor racing and results in additional usage of the brake power on the rear axle at the beginning of braking. A relatively high load applies on the rear axle at this point in time on account of the rear-mounted engine. This is exploited to transfer even greater braking force to the road and to further reduce the braking distance.

Similarly to the current 911 Carrera 4 models and the new 911 Turbo (997), the new 911 GT3 is also fitted with a 9-inch tandem brake booster. The brake power boost ratio has been revised especially for the new 911 GT3, however. While the sporty tuning results in slightly higher braking forces, it also enables improved dosing of braking force for enhanced driving dynamics. Further information on the tandem brake booster is to be found in the Marketing Concept or the Product Information for the 911 Carrera 4.



Fig. 24: PCCB

### Porsche Ceramic Composite Brake (PCCB)

As on the 911 GT3 (996), the Porsche Ceramic Composite Brake (PCCB) is also available as an option for the new 911 GT3.

Changes in relation to the 911 GT3 (996):

- Enhanced disc technology
- Large brake discs on the front axle
- Aluminium brake disc chambers on the front axle

A new feature on the 911 GT3 is the use of the enhanced disc technology which is already in standard use on the 911 GT2 (996) and the 911 Turbo S (996) from model year 2005 and is also available as an option for the 911 Carrera models.

The most important changes resulting from this optimised disc technology relate to the shaping of the inner cooling ducts to achieve increased ventilation accompanied by enhanced brake cooling and rigidity and the composition of the employed materials, resulting in increased wear resistance. The overall outcome is an increase in the performance of the brake system and a further extension of the brake system's service life.

Overview of brake systems	Standard brake system		Optional PCCB	
	New 911 GT3 (997)	911 GT3 (996)	New 911 GT3 (997)	911 GT3 (996)
Disc technology	Steel	Steel	Ceramic <b>optimised</b>	Ceramic
<b>Front axle</b>				
Brake callipers	6-piston monobloc fixed callipers	6-piston monobloc fixed callipers	6-piston monobloc fixed callipers	6-piston monobloc fixed callipers
Brake disc chamber	Steel	Steel	<b>Aluminium</b>	Stainless steel
Disc diameter (mm)	350	350	<b>380</b>	350
Disc thickness (mm)	34	34	34	34
Surface area per brake pad (cm <sup>2</sup> )	112.0	112.0	112	112
<b>Rear axle</b>				
Brake callipers	4-piston monobloc fixed callipers	4-piston monobloc fixed callipers	4-piston monobloc fixed callipers	4-piston monobloc fixed callipers
Brake disc chamber	Steel	Steel	Stainless steel	Stainless steel
Disc diameter (mm)	<b>350</b>	330	350	350
Disc thickness (mm)	28	28	28	28
Surface area per brake pad (cm <sup>2</sup> )	62	62	62	62
<b>Brake booster</b>	<b>Tandem 9 inch</b>	Single 10 inch	<b>Tandem 9 inch</b>	Single 10 inch

The optimised Porsche Ceramic Composite Brake (PCCB) also offers the familiar advantages over a brake system with grey cast iron brake discs:

- Faster response
- Very high fading stability thanks to consistent friction values
- High safety reserves under high levels of stress
- Approx. 50 % lighter than grey cast iron brake discs of the same design and dimensions
- Rust-proof brake discs

To further enhance braking performance, the diameter of the discs on the front axle of the new 911 GT3 has been increased from 350 mm to 380 mm, as on the 911 Turbo (997). These dimensions correspond to those on the Carrera GT (front and rear) and the front axle on the 911 GT3 Cup (997).

A new feature which is exclusive to the new 911 GT3 is the aluminium brake disc chamber on the front axle. The switch from steel to aluminium was successfully premiered on the new 911 GT3 Cup (997) in March 2005. The 911 GT3 adopts this technology, resulting in the advantage of a further reduction in the unsprung masses on the front axle. The aluminium brake disc chamber is approx. 50 % lighter than the steel variant. In addition to the light ceramic brake discs, this results in a further reduction in the unsprung masses for the vehicle as a whole of approx. 1.8 kg.

#### 4.7 Wheels and tyres

The new 911 GT3 comes with 19-inch light alloy wheels in the familiar “GT3 design” and sports tyres as standard. The wheels and tyres have been enlarged and widened on the rear axle in particular, with the aim of improving traction and, in turn, the car’s accelerating and braking capabilities. In order to exploit the potential for lateral acceleration and anti-rolling stability to the full, 5 mm spacers are additionally used on the rear axle. (Note: The spacers are not used in Japan, as these do not meet the necessary wheel covering requirements in accordance with the approval regulations which apply here).





Fig. 25: 911 GT3 wheel

In combination with the sports tyres designed especially for the vehicle, including enlarged tyre contact areas, the newly dimensioned wheels offer the following advantages:

- Very high lateral acceleration with high cornering speeds
- Exact handling and steering
- Optimum acceleration and braking performance

The sports tyres (also known as UHP or Ultra High Performance tyres) first featured as standard on the 911 GT3 RS (1996). These tyres have been developed as a new variant designed especially for the new 911 GT3, in keeping with the development of the chassis and the vehicle as a whole. On dry surfaces in particular, they offer very high performance potential with high traction, high lateral acceleration and short braking distances. The wet handling characteristics on damp surfaces and the general wear properties are comparable to those of standard tyres. In the case of “stagnant” water on the road surface, e.g. after heavy rain, an increased danger of aquaplaning is to be expected in comparison to standard tyres.

### Tyre repair system

Similarly to the 911 GT3 (1996), the current 911 Carrera generation and the new 911 Turbo (1997), the new 911 GT3 also comes with a tyre repair system. This familiar system comprises a tyre sealing compound and a compressor including integrated air pressure tester. As additional standard features worldwide and on all equipment variants, the new 911 GT3 additionally comes with a separate air pressure tester and two guide bolts to protect the optional ceramic brake discs (PCCB) when changing a wheel. The separate air pressure tester is intended above all for the repeated, swift checking of tyre pressure, particularly in racing use. Similarly to the tool kit, the elements of the tyre repair system are accommodated in a storage tray at the bottom of the luggage compartment floor.

<b>Technical data</b>		<b>New 911 GT3</b>	911 GT3
<b>Wheels and tyres</b>		(1997)	(1996)
Name		<b>19-inch</b> GT3 wheel	18-inch GT3 wheel
Front axle	Wheels	8.5J x <b>19</b>	8.5J x 18
	Tyres	235/ <b>35 ZR 19</b>	235/40 ZR 18
	Rim offset	<b>53 mm</b>	40 mm
Rear axle	Wheels	<b>12J x 19</b>	11J x 18
	Tyres	<b>305/30 ZR 19</b>	295/30 ZR 18
	Rim offset	<b>68 mm</b>	63 mm
Tyre type		<b>Sports tyre</b>	Standard tyre
<b>Track widths</b>			
Front axle		1,497 mm	1,485 mm
Rear axle		1,524 mm	1,495 mm



Fig. 26: The new 911 GT3

## 5 Body

Low weight for high performance is the overriding aim for all sports-oriented vehicles. This is particularly true of the GT models of the 911 model line. The new GT3 meets this requirement with a slimline body based on the current 911 Carrera models.

Strictly speaking, the body of the new 911 GT3 is actually a combination of the body-in-white of the current 911 Carrera 4 models and the outer skin of the current 911 Carrera models. As on the 911 GT3 (996), this combination with the body-in-white of the 911 Carrera 4 models enables the incorporation of a large fuel tank with a refillable volume of 90 l (911 GT3/996: 89 l).

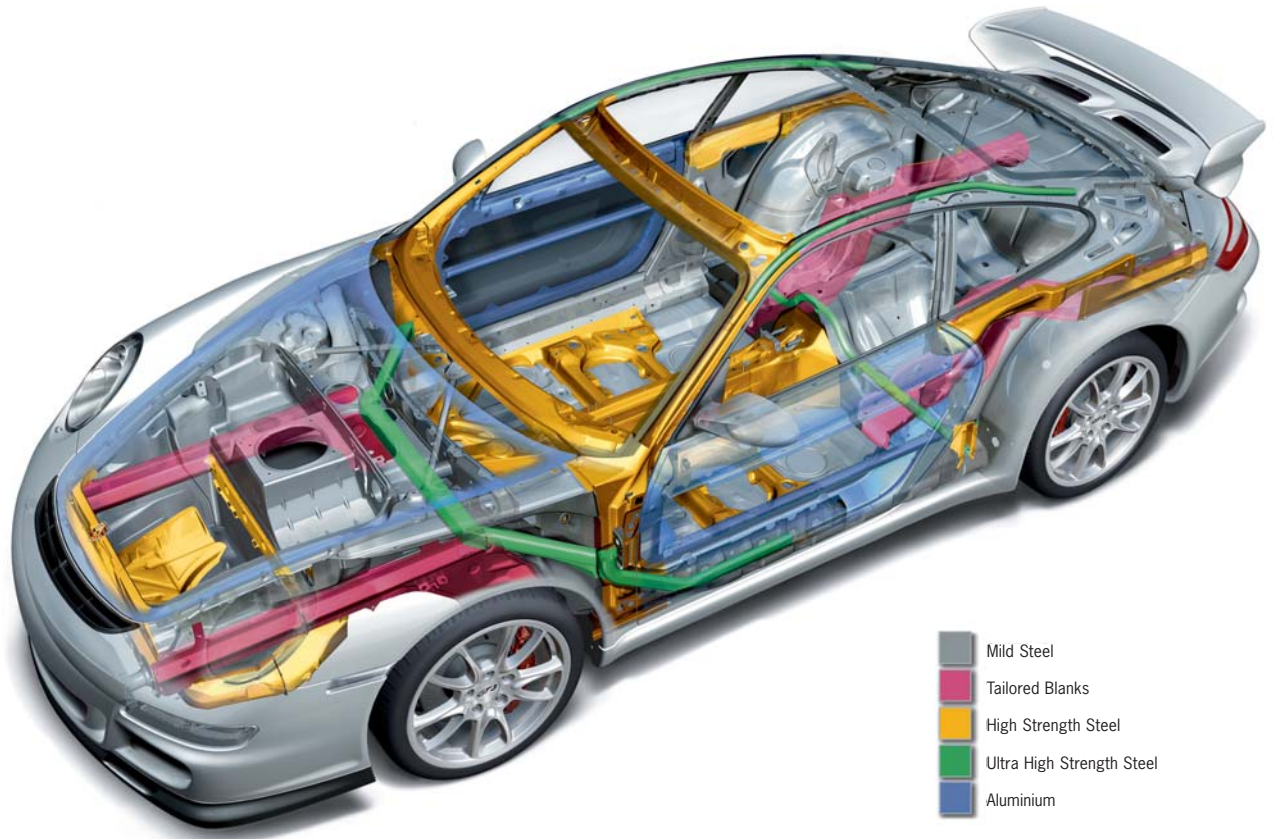

Fig. 27: Body-in-white

## 5.1 Body-in-white

The body-in-white of the new 911 GT3 is essentially a combination of the current 911 Carrera 4 models and the “crash insert” of the 911 Carrera models.

Similarly to the 911 GT3 (996), the new 911 GT3 also features additional welded sleeves on the rear cross frame to hold the sub-frame. This provides for more uniform transmission of the loads from the engine and transmission which act on the body via the sub-frame. These loads involve greater forces than apply on the 911 Carrera models, due to the higher weight of the engine/transmission unit (including separate engine oil tank for the dry sump lubrication system) and the more rigid suspension.

Similarly to the current 911 Carrera models, on the basis of the described body measures the torsional rigidity of the new 911 GT3 has been increased by 8 % and its flexural rigidity by 40 % over the predecessor model.

In order to minimise the vehicle’s weight, the luggage compartment lid and the doors on the new 911 GT3 are made of aluminium. The luggage compartment lid has been adopted from the current 911 generation and is approx. 6 kg lighter than a sheet steel lid. The aluminium doors originate from the new 911 Turbo and enable weight savings over a steel variant of approx. 7 kg per door.



Fig. 28: Front apron

## 5.2 Front apron

The front apron on the new 911 GT3 has been developed on the basis of the Aerokit Cup aerodynamic package which is available as an option for the current 911 generation. The increased cooling requirements and improved dynamics for the 911 GT3 were taken into account in developing the front apron for the Aerokit Cup. New characteristic features of the new 911 GT3 in this respect are:

- An additional air vent opening in front of the luggage compartment lid
- Additional air guiding fins on the lower part of the front apron
- Front spoiler lip in black (unpainted)

In a similar design to on the 911 GT3 RS (1996), the additional air vent opening in front of the luggage compartment lid guides the exhaust air from the middle radiator over, rather than under the vehicle. In addition to improved air flow through the radiators accompanied by increased cooling capacity, this measure also results in aerodynamic downforce at the front axle.

The exhaust air from the radiators installed in the sides of the front apron is guided via wheel house liners which have been developed especially for the new 911 GT3 and used specifically to cool the brakes. In order to reduce the vehicle's weight the 911 GT3, similarly to its predecessor, does without the blower which is installed behind the left-hand radiator on the 911 Carrera models. As a further means of cooling the brakes, the front spoiler lip on the new 911 GT3 incorporates side openings similar to those on the Aerokit Cup package, which guide the air specifically to the brakes on the front axle.

The front spoiler lip on the new 911 GT3 is always black and unpainted. In conjunction with the approx. 30 mm lower vehicle position in comparison to the current 911 Carrera models, for aerodynamic reasons the bottom edge of the front spoiler lip is located very low and close to the road surface on the new 911 GT3, too. Damage to the front spoiler lip, e.g. when driving along steep ramps and on very uneven road surfaces, cannot always be ruled out in this exposed position. For this reason, the

front spoiler lip on the 911 GT3 is treated as a wearing part, as on the 911 GT3 (1996) and the 911 GT2 (1996). In order to minimise the costs of wearing parts and the cost of replacing the front spoiler lip, the latter remains unpainted on the new 911 GT3, in contrast to the Aerokit Cup. The colour is black, corresponding to the employed polypropylene material (PP).

In order to improve cooling of the brakes on the front axle, air guiding fins are additionally fitted to the underbody behind the side openings in the front spoiler lip. These direct the inflowing air onto the deflection blades which are mounted on the front wheel cross members and then on to the front brake discs.



### 5.3 Rear apron

The rear apron including internal heat shield has been developed especially for the new 911 GT3. New, characteristic features of the new 911 GT3 in this respect are:

- The recess in the middle for the central dual tailpipes
- Additional side vent slots

The black chrome-plated central dual tailpipes are a characteristic design element of the new 911 GT3 modelled on the tailpipes of the 911 GT3 Cup racing cars. They are also a distinguishing feature of the exhaust system featuring low flow resistance. The additional vent slots enable the specific discharge of heat from the catalytic converts and front silencers located under the rear apron.

### 5.4 Rear lid with rear wing

The entire unit comprising the rear lid with fixed wing has been developed especially for the new 911 GT3. The aim in developing this unit was to combine low weight with optimised aerodynamic coefficients at the rear end.

In contrast to the 911 GT3 (996), two additional ram air boxes are mounted on the rear lid of the new 911 GT3 for efficient air intake and ventilation of the engine compartment. The ram air system which was originally introduced on the 911 GT3 RS (996) with one ram air box for the entire engine has undergone further development and optimisation. Two air boxes with separate ducting for the scavenging air and the intake air are used on the new 911 GT3. The air box on the left as seen in the direction of travel is responsible for purging and thus cooling the engine compartment, while



Fig. 29: Rear apron



Fig. 30: Rear wing

the air box on the right supplies intake air to the engine.

The ram air system supports air intake for the engine at high speeds in particular by damming up the air flowing over the vehicle. This is accompanied by a slight increase in pressure throughout the intake system and a reduction in the intake work required of the pistons. The overall outcome is a slight increase in engine performance. Apart from enabling the more efficient supply of air to the respective functional areas, using

two air boxes with separate duct systems for purging and intake air also largely prevents the intake of hot air from the engine compartment, which can have an adverse effect on engine performance in particular.

The position and shaping of the new rear wing have been designed specifically in accordance with the optimised aerodynamics of the new 911 GT3. This enables an ideal aerodynamic balance between the front and rear axle in conjunction with a  $c_d$  value of 0.29, which is

outstanding for this class of vehicle (911 GT3/996:  $c_d = 0.30$ ). The wing tilt can be adjusted by 3 or 6 degrees for use on the race track.

## 5.5 Fuel tank

A new fuel tank has been developed for the new 911 GT3. As on the 911 GT3 (996), using the front section from the body-in-white of the 911 Carrera 4 models enables a large fuel tank to be fitted.

Similarly to on the 911 GT3 (996), the space in which the front final drive is installed on the 911 Carrera 4 models is used to increase the volume of the tank. The new tank enables a further increase in the usable tank capacity on the new 911 GT3 to 90 l (911 GT3/996: 89l). As on the 911 GT3 (996), the tank itself is essentially a combination of the upper part of the tank from the 911 Carrera 4 models and the lower part of the tank from the 911 Carrera models.

## 5.6 Luggage compartment

The luggage compartment on the new 911 GT3 essentially corresponds to that on the current 911 Carrera 4 models. The luggage compartment volume of approx. 105 l is on a par with the approx. 110 l offered by the 911 GT3 (996). The slight reduction of approx. 5 l results from a change to the shape of the luggage compartment, with enhanced crash protection including an additional crash insert in the luggage compartment floor.

As on the 911 GT3 (996), parts of the tyre repair system are accommodated under a cover in the floor of the luggage compartment. Additionally accommodated under this cover on the new 911 GT3 are a separate air pressure tester and two guide bolts as an aid to fitting wheels, particularly in conjunction with the optional ceramic brake discs (PCCB). The additional small air pressure tester provides for simple handling when checking the air pressure and is intended in particular for intensive use on race circuits.

In keeping with the current 911 generation, the new 911 GT3 also features the familiar emergency release for the luggage compartment lid inside the luggage compartment (trunk entrapment) in the NAFTA states.

<b>Overview of tank volumes (refillable volumes)</b> Figures stated in litres	<b>New 911 GT3</b> (997)	<b>911 GT3</b> (996)
USA, RoW - left-hand drive	<b>90</b>	89
USA, RoW - right-hand drive	<b>67</b>	64
USA	<b>67</b>	63



## 5.7 Interior

The interior equipment of the new 911 GT3 is based on the current 911 generation, borrowing components from the 911 GT3 RS (996) and the Carrera GT. The following features distinguish the new 911 GT3 and underline its sporty character:

In Alcantara finish:

- Centre sections of all available seat variants (apart from Clubsport)
- Rim of the standard 3-spoke GT3 steering wheel
- Shift lever handle
- Handbrake lever grip

Other specific features

- Instrument cluster with yellow pointers and increment markings, shift indicator and GT3 logo on the tachometer
- Sill covers and carpet on rear wall with GT3 logo

Key changes in comparison to the 911 GT3 (996) on the basis of the current 911 Carrera generation:

- New interior design
- New steering wheel, shift lever and seat generation
- Additional height adjustment of the steering wheel
- New side airbag system (door trim panels: head airbag; seats: thorax airbag)
- More forward positioning of the pedals
- Lower seat position with sports seats
- Front centre console as standard (911 GT3/996: option)
- Air conditioning as standard (911 GT3/996: no cost option)



Fig. 31: Interior



Fig. 32: Interior

Detailed customer benefits resulting from the respective changes adopted from the new 911 Carrera generation are to be found in the Marketing Concept and Product Information for the 911 Carrera.

The scope of equipment on the new 911 GT3 is extended by the additional elements finished in Alcantara, comprising the steering wheel rim, the gear lever and handbrake lever handles and the centre section of the available seats (apart from Clubsport). This material concept, which was first featured in the 911 GT3 RS (996), enhances the appearance of the interior by establishing associations with motor racing while



Fig. 33: Carbon interior

at the same time improving functionality by providing the controls relating to driving dynamics (steering wheel, shift lever and handbrake lever) with a better grip.

The interior of the new 911 GT3 is further enhanced by an instrument cluster featuring a new colour concept based on the Carrera GT. The new 911 GT3 possesses its own distinctive and char-

acteristic instrument cluster, with yellow pointers and increment markings and a titanium-coloured dial highlighting the tachometer, which also features the “GT3” logo.

The colour of the interior features in the new 911 GT3 including the fitted carpeting is black. As on the 911 GT3 (996) colour highlights can be added by the 3-

point seat belts, which are available in Guards Red, Speed Yellow and Silver Grey, as well as black.

Optionally, the new 911 GT3 is also available with a leather interior in black or dark grey natural leather. Additional leather and carbon packages are optionally available for further customisation.



Fig. 34: Dark grey natural leather interior



Fig. 35: Optional 3-spoke sports steering wheel in smooth leather

The steering wheel of the new 911 GT3 has been developed on the basis of the familiar 3-spoke sports steering wheel from the new 911 generation, including additional height adjustment. In contrast to the 3-spoke sports steering wheel, the Alcantara-finished steering wheel rim is slightly padded by the thickness of the Alcantara material. In combination with the trims on the steering wheel spokes in painted Volcano Grey finish, this represents a distinguishing feature which is specific to the 911 GT3, including enhanced grip and functionality. The 3-spoke sports steering wheel in smooth leather (I 459) and the padded 3-spoke sports leather steering wheel in smooth leather (XPA) from the current 911 Carrera generation are optionally available.

Similarly to the current 911 Carrera generation, the new 911 GT3 also comes with optimised sports-look pedals featuring new pedal caps and more forward positioning. This measure now enables particularly tall people to find a comfortable seated position, too. This repositioning of the pedals has been made possible mainly through the new bulkhead cross member in the body-in-white. This has allowed the brake and accelerator pedals to be moved forward by 10 mm and the clutch pedal by 15 mm.

The new 911 GT3 is fitted worldwide with sports seats including Alcantara centre section as standard. The familiar thorax airbags are incorporated in these seats. These form part of the new side airbag system for the current 911 generation and combine with the separate head airbags in the doors to offer improved side impact protection.

Lightweight bucket seats are optionally available. These extremely light bucket seats originate from the Carrera GT and are produced in high-tech carbon fibre material. They represent weight savings of approx. 24 kg per vehicle in comparison to the standard sports seats. Apart from their extremely low weight, these seats featuring a visible carbon fibre structure also offer a very high level of lateral support and excellent comfort on long journeys. In keeping with the interior concept of the new 911 GT3, the trims on the seat belt openings in the head area are painted in Volcano Grey instead of Silver (Carrera GT) and the centre sections of the seats are finished in Alcantara rather than leather (Carrera GT).

The lightweight bucket seats do not incorporate thorax airbags. In order to nevertheless ensure a high level of side impact protection in the new 911 GT3, special door panels including energy-absorbing impact elements (“door pads”) are supplied automatically when the lightweight bucket seats are ordered. The door storage bins are omitted when the impact elements are supplied.



Fig. 36: Adaptive sports seat



Fig. 37: Lightweight bucket seat

## 5.8 Clubsport package

As for the 911 GT3 (996), a Clubsport package is also available as a no cost option for the new 911 GT3. This package comprises the following features:

- Bolted-on roll cage at rear
- Preparation for battery main switch
- 6-point seat belt in red for the driver's side (supplied with the package)
- Fire extinguisher with bracket (supplied with the package)

The Clubsport package can only be ordered together with the carbon fibre lightweight bucket seats option for the new 911 GT3. In conjunction with the Clubsport package, the seats, which originate from the Carrera GT, are upholstered in a highly flame-retardant material instead of leather. This combination of elements has been chosen with due regard to customer-oriented use of the Clubsport package in particular on race circuits, imposing high requirements with regard to the lateral support offered by the seats.

For use in racing events under FIA GT rules, both the battery main switch and special side extension bars for roof and A-pillars (to extend the safety cage) are available as racing parts from the Porsche motor racing department.



Fig. 38: Clubsport package



Fig. 39: Clubsport package





Fig. 40: The new 911 GT3

## 6 Aerodynamics

As with all Porsche models, exclusive design on the new 911 GT3 does not conflict with the outstanding aerodynamic properties of the vehicle as a whole. In this context, the following aerodynamic challenges have been addressed in developing the new 911 GT3.

- High cooling air requirements for the engine and brakes necessitate large air inlets in the front section, which are not conducive to attaining a good drag coefficient
- Measures to reduce undesired lifting forces at the front and rear of the car involving aerodynamic elements such as front and rear spoilers also result in a higher drag coefficient than applies to a vehicle without such spoilers
- Wide wheel/tyre combinations to maximise traction enlarge the vehicle's frontal area, entailing an attendant increase in drag ( $c_d \times A$ )

With the aid of extensive tuning work in the wind tunnel and systematic application of the experience acquired with the 911 GT3 Cup in motor racing, it has been possible to provide the new 911 GT3 with aerodynamic downforce and an outstanding  $c_d$  value for this class of vehicle of 0.29 (911 GT3/996:  $c_d = 0.30$ ).

The design of the front end, the wheel arches, the rear lid with wing, the rear end and the underbody has been instrumental to achieving this success. The new front apron with the separate spoiler lip incorporating brake air inlets and the new routing of the air discharged from the central radiator over the top of the vehicle has resulted in a marked reduction in the air flow under the vehicle. As a result of the ideally positioned cooling-air openings, the air issuing behind the side radiators is guided directly to the brake system, rather than into the wheel house as is the case on the current 911 Carrera models. This measure also makes a significant contribution towards reducing the lift at the front axle.

The aerodynamic measures at the front and rear ends have been designed to ensure optimum balance at the front and rear axles. The rear wing offers enhanced aerodynamic efficiency in comparison to the 911 GT3 (996), i.e. it generates downforce while maintaining the same level of drag. The rear wing is additionally adjustable by 3 or 6 degrees for race circuit use.

Apart from lowering the vehicle's centre of gravity, lowering the vehicle by approx. 30 mm in comparison to the current 911 Carrera also improves the car's aerodynamic qualities. This measure reduces the vehicle's drag-inducing frontal area and the air flow under the vehicle, which generates undesired lifting forces.



Fig. 41: The new 911 GT3

Similarly to the current 911 Carrera models and the new 911 Turbo (997), the underbody on the new 911 GT3 is also lined with large panels for good aerodynamics. The key elements correspond to the underbody lining on the new 911 Turbo (997), including the additional brake cooling on the rear axle.

As on the 911 GT3 (996), the air flow around the wheels is improved with the aid of wheel spoilers in front of the rear wheels, thereby also reducing the lifting forces. In conjunction with the aerodynamic balance tailored to the chassis, this enables outstanding driving characteristics into the highest speed ranges.

In order to exploit all the available potential, the new 911 GT3 also meets the high aerodynamic requirements by means of inconspicuous details, such as the small spoilers in the front area and the plastic underbody lining. In addition to its aerodynamic purposes, the underbody lining is also used to cool highly stressed components by means of specific ventilation openings. A coordinated system of air ducts and guide blades additionally ensures the supply of cooling air to the brakes, thereby enabling the brake system to withstand exceptional levels of stress in extreme driving conditions.



## 7 Electrics

The electrical features of the new 911 GT3 are based on those of the current 911 Carrera generation. Corresponding basic information is to be found in the Product Information on the 911 Carrera. The following sections describe the features which are specific to the new 911 GT3.

### 7.1 Battery

Similarly to the 911 GT3 (1996), the new 911 GT3 also employs a battery with a capacity of 60 Ah in the interest of weight reduction. This is approx. 2.8 kg lighter than the 70 Ah battery used in the current 911 Carrera models.

### 7.2 Lighting

In keeping with the current 911 generation, the new 911 GT3 also features headlights with separate front lights, indicator lights and rear lights.

#### Main headlights

The new 911 GT3 is fitted as standard with the projector-type halogen main headlights which are familiar from the current 911 Carrera generation.



Fig. 42: Bi-Xenon

#### Bi-Xenon (option)

As on the 911 GT3 (1996), the familiar Bi-Xenon headlights with headlight washer system are also available as an option for the new 911 GT3. Similarly to the Carrera GT, the new 911 GT3 also does without dynamic range adjustment in the interest of reducing the vehicle's weight. This is made possible by a rigid suspension set-up with small spring travel and only minor body movement, e.g. when accelerating. As a result, the statutory tolerance ranges for alteration of the light cone from the headlights are observed without dynamic range adjustment.

#### Interior lighting

In keeping with the current 911 generation, the new 911 GT3 is also provided with white LEDs for the instruments and controls, as opposed to yellow LEDs. The resultant marked increase in illuminating power has improved the readability of the instruments, particularly at dawn and dusk. In addition, the white lighting also lends the interior a very high-quality appearance.



Fig. 43: Instrument cluster

### 7.3 Instruments

The instruments for the new 911 GT3 have been specifically adapted to distinguish the new 911 GT3, on the basis of the current 911 Carrera. Modelled on the Carrera GT, the instruments on the new 911 GT3 possess the following characteristic distinguishing features:

- Yellow pointers
- Yellow increment markings
- Highlighting of the tachometer by means of a titanium-coloured background

The new 911 GT3 also features the familiar “GT3” logo in the tachometer. In view of the further increase in the engine’s cut-off speed, the red range now begins at 8,400 rpm.

A shift indicator features for the first time on the instrument cluster of the new 911 GT3. Shortly before the maximum engine speed of 8,400 rpm is attained, an upward-pointing arrow lights up in the tachometer. During sporty acceleration using the entire rev range, the arrow lights up to prompt the driver to change up a gear. The point at which the arrow lights up varies according to the currently engaged gear, so as to enable the best possible acceleration.

## 8 Audio and communication

### 8.1 CD radio and loudspeakers

The new 911 GT3 is fitted worldwide with the Porsche CDR-24 radio which is familiar from the current Boxster (S) as standard, featuring a dual tuner, CD drive and 4 loudspeakers.

The new Porsche CDR-24 radio generation features a more ergonomic operating concept than the Porsche CDR-23 (911 GT3/996). The substantially larger control panel (double-height) results in a marked improvement in clarity and handling.

The new Porsche CDR-24 radio incorporates all the established features, such as double tuner, 30 presets (20 FM, 10 MW, plus 9 for Autostore), background traffic station, high-end CD drive etc.

Similarly to the 911 GT3 (996), the new 911 GT3 is also fitted with 4 loudspeakers as standard. In the 911 GT3 (996) these were accommodated in the dashboard and in the sides at the rear. For improved three-dimensional sound projection, the loudspeakers in the new 911 GT3 are installed in the dashboard and the doors, as in the current 911 generation.

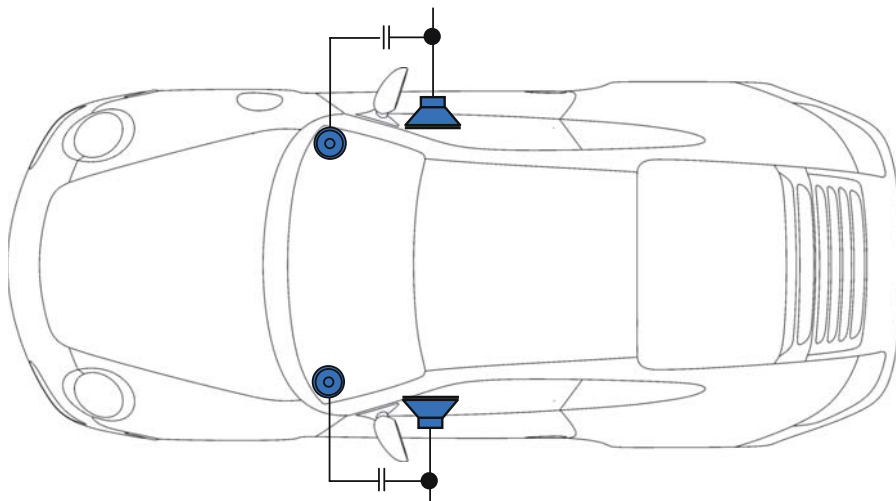

Fig. 44: Standard loudspeaker system in the 911 GT3

One 1.9 cm tweeter is installed on the right and left sides of the dashboard respectively and one 16.5 cm low/medium-range loudspeaker is fitted in each of the doors. As a result of this configuration, the standard new high-quality loudspeakers enable excellent sound reproduction and a high maximum distortion-free playback volume.

### 8.2 Antenna system

Similarly to the 911 GT3 (996), the new 911 GT3 is also fitted with a powerful window antenna as standard. The PCM option provides the customer with the antenna diversity which is familiar from the current 911 Carrera generation. The corresponding antennas are incorporated in the windscreen and improve VHF reception in the event of interference. A rod antenna is available as a no cost option to improve medium-wave reception. This is located in the rear area of the roof.



Fig. 45: Centre console in the 911 GT3 with PCM

### 8.3 PCM with navigation (option)

Porsche Communication Management (PCM) is being offered as an optional package in combination with the navigation module for the first time on the new 911 GT3. This 911 GT3-specific product strategy will enable both customers attaching high priority to weight factors (standard CDR-24 radio) and customers placing greater emphasis on communication (optional PCM with navigation) to choose the audio alternative which is best suited to their personal needs.

The design and features of PCM and the navigation module correspond to those for the current 911 models. Basic information is to be found in the Product Information on the 911 Carrera.

### 8.4 Sound Package Plus (option)

The Sound Package Plus option is available for the new 911 GT3 with the standard CDR-24 radio and optional PCM including navigation module. The features correspond to the standard scope offered in the current 911 Carrera generation.

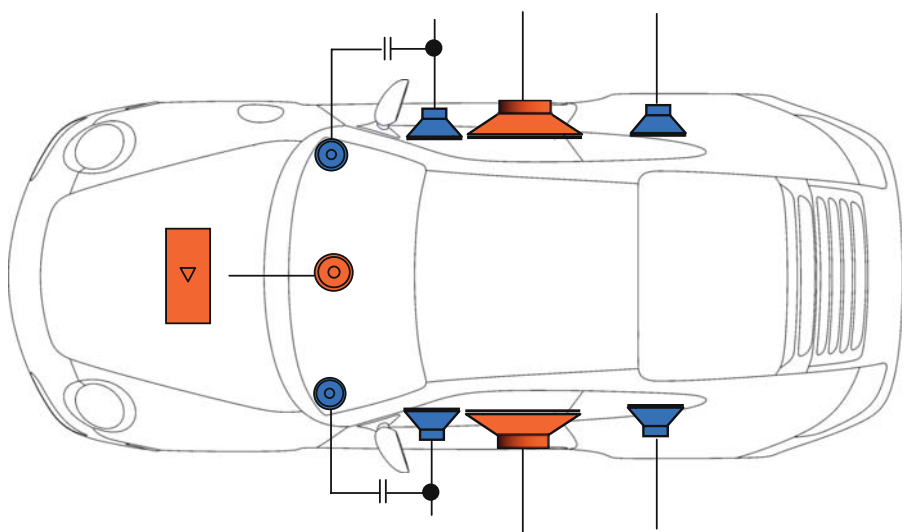

Fig. 46: Sound Package Plus loudspeaker system

With a total of 9 loudspeakers and an external linear amplifier, it offers an outstanding sound experience with adequate reserves. This is achieved by using large, superior-quality loudspeakers.

The following loudspeakers are used:

- Dashboard:

- 2 1.9-cm tweeters
- 1 7.0-cm mid-range loudspeaker (centre speaker)

- Doors:

- 2 10.0-cm mid-range loudspeakers
- 2 20.0-cm low-range speakers

- Rear side speakers:

- 2 10.0-cm mid-range loudspeakers

The loudspeakers are powered by the 4 x 25 W linear amplifier integrated in the Porsche CDR-24 radio / PCM and by an external linear amplifier in the luggage compartment. The external amplifier supplies the power for the low-range loudspeakers (2 x 55 W) and the mid-range loudspeakers in the dashboard (25 W). This results in an overall rated power of 235 W.

In order to adapt the Sound Package Plus option to the special interior acoustics of the new 911 GT3, analogue filter stages are employed in the external amplifier to achieve well-balanced sound reproduction throughout the interior even at very high volumes.

### **8.5 Telephone module for PCM (option)**

A telephone module is being offered for the PCM for the first time on the new 911 GT3. The employed system, which is familiar from the current 911 generation, features a hands-free facility with improved speech quality and a hands-free microphone on the steering column. The triband telephone is suitable for GSM 900, 1800 and 1900 networks and is consequently also available in the USA.

### **8.6 Telephone preparation for mobile phone (option)**

As for the 911 GT3 (996), a telephone preparation option for a mobile phone is also available for the new 911 GT3. This option comprises the antenna, which is installed in the plenum chamber in front of the windscreen, the basic cabling, the microphone for the hands-free function, the VDA interface for adaptation of the upgrade kit and an attachment console for the telephone holder.



Fig. 47: Stopwatch

### **8.7 Chrono Package (option)**

The new "Chrono Package" option which is being introduced for the 911 GT3 is based on the "Sport Chrono Package" option for the current Boxster and the "Sport Chrono Package Plus" option for the 911 Carrera generation. The sports functions such as sporty engine and chassis set-up which are normally activated in the 911 Carrera and Boxster models via the Sport button on the centre console come as standard on the new 911 GT3. For the new 911 GT3, the scope of features is thus limited to the analogue stopwatch on the dashboard and the digital stopwatch on the instrument cluster.

### **Chrono Package Plus (option)**

The new "Chrono Package Plus" option for the 911 GT3 is also based on the Chrono Package option. This option additionally incorporates the "Plus" features from the Sport Chrono Package Plus option for the current 911 Carrera generation. This option thus includes the following additional features:

- Performance display in the PCM
- Individual memory

Note: The "Chrono Package Plus" option can only be ordered for the new 911 GT3 in conjunction with the Porsche Communication Management (PCM) option including navigation module.



## 9 Safety

All safety-related features on the new 911 GT3 essentially correspond to those on the current 911 Carrera models. For detailed information, please refer to the corresponding Marketing Concepts/Product Information.

### 9.1 Active safety

The new 911 GT3 offers a further improved standard of active safety, thanks to its high acceleration and deceleration values, the rigid basic tuning of the chassis to counter rolling and additional components which were not available on the 911 GT3 (996) in the form of Porsche Active Suspension Management (PASM) and Traction Control (TC) to promote driving stability during acceleration.

### 9.2 Passive safety

The new 911 GT3 complies with all the currently valid legislation and approval regulations with regard to passive safety in the markets in which it is available.

The body-in-white structure has been largely adopted from the current 911 Carrera generation. Energy is absorbed at the front of the car by straight side members with cross-sections designed for optimum energy absorption, which transmit the forces introduced in the event of impact into the bulkhead cross-member made of high-strength steel to reduce footwell intrusion in a crash. The fuel tank is positioned behind the deformation zone and is additionally protected by the front axle bracket. The fuel pipes are located outside of the deformation zone.

In keeping with the new 911 generation, in addition to the safety elements in the body-in-white the new 911 GT3 is also equipped with six airbags and an energy-absorbing door panel including door reinforcements. The airbag system comprises two-stage full-size airbags for driver and front passenger, thorax airbags integrated in the sides of the seats to protect the upper part of the body in the event of side impact and head airbags accommodated in the upper part of the door-trim panel. When the optional lightweight bucket seats are fitted, the padding in the lower area of the door-trim panel protects the upper part of the body in the event of side impact, instead of the thorax airbags.

# 10 Equipment

## 10.1 Standard equipment (EU model)

The following overview presents the standard equipment of the new 911 GT3.

<b>Engine:</b>
6-cylinder horizontally-opposed engine, 3.6 l displacement, maximum output 305 kW (415 bhp)
Engine technology: <ul style="list-style-type: none"><li>- Aluminium engine block and cylinder head</li><li>- water cooling</li><li>- 4-valve technology</li><li>- titanium connecting rod</li><li>- camshaft adjustment "VarioCam"</li><li>- hydraulic valve clearance compensation</li><li>- dry sump lubrication with external engine oil tank</li><li>- electronic engine management (Motronic ME7.8)</li><li>- electronic gas pedal</li><li>- hot film air flow sensor</li><li>- sequential fuel injection (multipoint)</li><li>- cylinder-selective knock control</li><li>- two 3-way catalytic converters</li><li>- Stereo Lambda control</li><li>- individual ignition coils, static high-voltage ignition system</li><li>- variable intake system with 2 switchable tuning flaps</li><li>- On-Board diagnosis system for monitoring emission control system</li><li>- sport exhaust system with centre dual tailpipes</li></ul>
<b>Transmission:</b>
6-speed manual transmission with dual-mass flywheel and transmission fluid cooling
Rear-wheel drive
Traction Control
Asymmetric locking differential (28/40%)
<b>Chassis:</b>
8.5 J x 19 GT3 light-alloy wheels with 235/35 ZR 19 sports tyres, front 12 J x 19 GT3 light-alloy wheels with 305/30 ZR 19 sports tyres, rear
Wheel hub cover with "GT3" logo
Anti-theft wheel bolts
Tyre sealing compound with electric compressor and separate air pressure tester
Power-assisted steering with variable steering ratio
McPherson spring strut axle, front anti-roll bar
LSA multi-link rear axle, rear anti-roll bar
Porsche Active Suspension Management (PASM), including sport setup 30 mm lower than 911 Carrera
Adjustable chassis for use on race circuits (toe, camber, anti-roll bar)
<b>Brake system:</b>
6-piston monobloc fixed-calliper brakes at front, 4-piston monobloc fixed-calliper brakes at rear, Brake disks internally vented and perforated
Reinforced brake system with brake disk diameter 350 mm front and rear
ABS 8.0
Brake pad wear sensors on each brake pad
Brake callipers painted red

<b>Body:</b>
Two-seater coupé
Sheet steel hot-dip galvanized on both sides
Front apron with spoiler lip and additional air outlets before luggage compartment lid
Rear lid with 2 ram air boxes and fixed wing
Logo "GT3" on rear lid, black
Rear apron with additional air outlets and centre dual tailpipes
Aluminium luggage compartment lid
Aluminium doors
Underbody lining
Curved door handles
Door stops with 3 index positions
Side windows at front with hydrophobic coating
<b>Electrics:</b>
Power windows with one-touch operation and short-stroke lowering
Windscreen washer system with 2 wiping speeds, adjustable intermittent wipe and heated washer jets
Electrically adjustable heated exterior mirrors (double-arm), (aspherical on driver's side)
Heated rear window
Radio CDR-24 with 2 x 25 Watt, 4 loudspeaker
Uniform lighting concept for the entire interior, continuously variable dimming in white
Interior orientation lighting (ignition lock, door handles, centre console)
Footwell lighting
Remote central locking including luggage compartment
Power luggage compartment and engine lid release
Weight-reducing battery
<b>Lighting system:</b>
Clear-glass H7 projection beam headlights (halogen)
Separate additional lights in the front end with marker light, indicator light and fog light
Rear fog light on driver's side
Raised third brake light in LED technology
Coming home lights
<b>Instruments:</b>
5 dial-type instruments integrated in the cockpit
Instrument cluster with yellow pointers and increment markings as well as multi-function indicator in dot-matrix display
Central tachometer with titanium-colored background, "GT3" logo and shift indicator
Analogue display for engine speed, vehicle speed and oil pressure, oil temperature, coolant temperature and fuel level
Permanent digital display of total mileage, trip mileage, time, outside temperature and speed
On-board computer

<b>Passive safety:</b>
Full-size airbags for driver and front passenger
Porsche Side Impact Protection System (POSIP), comprising side impact protection in the doors, thorax airbags integrated in the side sections of the front seats and head airbags for driver and front passenger integrated in the door panels
3-point automatic seat belts, front, with buckle on seat
Belt height adjustment, seat belt pre-tensioners and force limiters in the front
Preparation for subsequent installation of the child seat anchoring system ISOFIX on the front passenger seat and deactivation option for front passenger airbag
Immobilizer, safe locking system, alarm system and interior radar surveillance system
Deformation zones at front and rear with integrated alloy bumpers
<b>Air conditioning:</b>
Automatic air conditioner with integrated active charcoal filter
Green tinted heat-insulating glass
<b>Interior equipment:</b>
Sports seats with Alcantara inserts, electric backrest adjustment as well as manual front/aft and height adjustment, without rear seat system
3-spokes "GT3" steering wheel with Alcantara steering wheel rim and spoke trim in painted volcano grey finish, manual length and height adjustment
Alcantara shift lever and parking brake handle
Interior parts painted in volcano grey: Shift pattern trim, decorative trim on shift lever
Roofliner in Alcantara
Lockable, large glove compartment
Door storage bins
Centre console with 3 storage compartments
Cup holders located above the glove compartment (integrated behind the decorative switch panel trim)
Illuminated vanity mirrors in both sun visors (driver and front passenger side)
Door entry guards and rear carpet with "GT3" logo
<b>Colors:</b>
Exterior solid colors: Black, Guards Red, Carrara White, Speed Yellow
Interior standard colors: Black

## 10.2 Optional extras

		Product offering	Availability (at SOP = 04/2006)
O = Optional equipment W = Available at no extra charge			
<b>Exterior</b>			
Code	<b>Metallic paint</b> Colours: Basalt Black Metallic, Arctic Silver Metallic*, Midnight Blue Metallic, Atlas Grey Metallic, Meteor Grey Metallic*, Cobalt Blue Metallic  *Note: Meteor Grey Metallic will be available from 08/2006 at the earliest	0	at SOP*
Code	<b>Special colours</b> Special colours represent a selection of previously developed colours, some of which were in use in the past. Colour range: Lapis Blue Metallic, Dark Olive Metallic, GT Silver Metallic, Lagoon Green Metallic, Slate Grey Metallic, Carmon Red Metallic, Forest Green Metallic Minimum lead time: 2 months	0	at SOP
P74	<b>Bi-Xenon lighting system</b> Headlight system with gas discharge lamp and headlight washer system	0	at SOP
498	<b>Deletion of model designation</b>	W	at SOP
567	<b>Windscreen with grey top tint</b> Heavy tint on upper portion of windscreen	0	at SOP
P12	<b>Automatically dimming interior/door mirrors with integrated rain sensor</b> Integrated rain sensor with four-stage control for automatic wiper interval	0	at SOP
650	<b>Electric tilting/sliding sunroof</b> With automatic air deflector, electrically actuated with one-touch function	0	at SOP
<b>Chassis</b>			
450	<b>Porsche Ceramic Composite Brake (PCCB)</b> Ceramic brake system, carbon fibre-reinforced ceramic brake discs, internally vented and cross-drilled, brake disc diameter 380 mm front and 350 mm rear, 6-piston brake callipers on front axle and 4-piston brake callipers on rear axle, yellow paint finish on callipers	0	at SOP
446	<b>Wheel hub cover</b> With full-colour Porsche Crest	0	at SOP
XD9	<b>Wheels painted in exterior colour</b> Wheels featuring exterior colour in part, incl. wheel hub cover (order no. 446) with full-colour Porsche Crest	0	<b>07/2006</b>
482	<b>Tire Pressure Monitoring (TPM)</b> Continuous monitoring of tyre pressure and status display on instrument cluster, including warning of pressure losses	0	at SOP



		Product offering	Availability (at SOP = 04/2006)
O = Optional equipment W = Available at no extra charge			
<b>Interior</b>			
003	<b>Clubsport package</b> Bolted-on roll cage at rear, preparation for battery main switch Provided: 6-point belt for driver's side in Red and fire extinguisher with holder  Note: Only in combination with lightweight bucket seats (P02). Not in combination with natural leather interior.	W	at SOP
454	<b>Cruise control</b> Automatic speed control system	O	at SOP
XFG	<b>Instrument cluster dials in Guards Red</b> With "GT3" logo	O	<b>07/2006</b>
674	<b>Preparation for Vehicle Tracking System</b> Pre-wiring and increased battery capacity, required for retrofitting the Vehicle Tracking System from the Porsche Tequipment range.  Note: Further information on the Vehicle Tracking System is to be found in the Tequipment catalogue	O	at SOP
P02	<b>Lightweight bucket seats</b> Carbon-fibre bucket seats for driver and passenger side (based on Carrera GT), upholstered in leather/Alcantara, including manual fore-and-aft adjustment. Without thorax airbags. With door trim panels without storage bin.  Note: Not in combination with fire extinguisher (509)	O	at SOP
P01	<b>Adaptive sports seats</b> Electric adjustment of all seat functions without memory, plus 4-way side-piece adjustment, upholstered in leather/Alcantara	O	at SOP
342	<b>Heated seats</b> Left and right, multi-stage	O	at SOP
	<b>Seat belts</b> XSH Silver Grey XSX Guards Red SY Speed Yellow For driver and passenger seat	O	at SOP
XME	<b>Rear section of centre console in painted finish</b> Paint finish in exterior colour: Rear of centre console including ashtray cover, rear centre console storage bin. Smooth leather finish in interior colour: Handbrake lever handhold trim	O	at SOP
509	<b>Fire extinguisher</b> Compact DIN EN3 powder fire extinguisher containing 1kg of extinguishing agent, stored at the front, under the driver's seat  Note: Not in combination with lightweight bucket seats (P02)	O	at SOP
XXZ	<b>Sports-look footrest</b> Attachment for footrest fitted as standard in the driver's footwell, designed to match the standard pedals, made of durable material with a stainless-steel frame (brushed matt)	O	at SOP
810	<b>Floor mats</b> Black with Nubuk leather edging and embroidered Porsche logo at front (two-piece set)	O	<b>06/2006</b>

		Product offering	Availability (at SOP = 04/2006)
O = Optional equipment W = Available at no extra charge			
<b>Leather and natural leather interior</b>			
Code	<b>Black leather interior</b> Additional scope of leather features for standard interior: Trim A-pillar/windscreen frame, B-pillar trim, C-pillar trim, front part of switch panel incl. airbag cover, upper/lower part of switch panel incl. instrument cluster cover and glove compartment cover (three-part), upper/lower part of dashboard including instrument cluster cover and glove compartment cover (three-part), door trim including head airbag cover, front side trims, rear side trims, rear side trims, all leather items in smooth leather  Additional items in Alcantara: Door handle, door mirror, door storage compartment lid and centre console cover	0	at SOP
998	<b>Leather interior in natural leather</b> Natural Dark Grey. Leather through-dyed by means of a gentle process that maintains the material's natural characteristics. Same features as leather equipment. Plastic items finished in soft-touch black paint	0	at SOP
EAA	<b>Additional interior package with dashboard in leather</b> As leather interior but with the following additional features in smooth leather in interior colour: Side vents, side vent vanes, centre vent including switch trim, centre vent vanes, loudspeaker cover in dashboard (centre), defroster trim, decorative dashboard trim including cup holder cover	0	at SOP
XTV	<b>Additional interior package with door trim panels in leather</b> Smooth leather finish in interior colour: Door opener trim	0	<b>07/2006</b>
460	<b>3-spoke steering wheel in smooth leather</b> Smooth leather finish in interior colour: Steering wheel rim and airbag module	W	at SOP
XPA	<b>Padded 3-spoke sports steering wheel in smooth leather</b> With smaller steering wheel diameter, highly contoured rim with thumb rest and round airbag module. Smooth leather finish in interior colour: Padded steering wheel rim (with cross-stitched seam), airbag module, steering wheel hub trim. Smooth leather finish in interior colour: Door opener trim	W	at SOP
XSC	<b>Porsche Crest on head restraints</b> Embossed on head restraints on front seats	0	at SOP
XMZ	<b>Rear section of centre console in leather</b> Smooth leather finish in interior colour: Centre console at rear including ashtray cover, rear centre console storage bin, handbrake lever handhold trim	0	at SOP
<b>Carbon interior</b>			
EZA	<b>Carbon interior package</b> Carbon finish: Decorative dashboard trim including cup holder trim, five-part, shift lever (in part), upper part of handbrake lever. With Alcantara finish: Shift lever including decorative trim in Volcano Grey with white shift pattern, handbrake lever handle including insert in Volcano Grey with white "GT3" logo	0	<b>07/2006</b>
EZB	<b>Additional Carbon interior package</b> Carbon finish: Inserts in defroster trim, side vents, centre vent, door handle trim. Smooth leather finish in interior colour: Side vent vanes, centre vent vanes incl. switch trim, loudspeaker switch panel cover, defroster trim (in part)	0	<b>07/2006</b>
XMJ	<b>Rear section of centre console in Carbon</b> Carbon finish: Rear of centre console including ashtray cover, rear centre console storage bin. Smooth leather finish in interior colour: Handbrake lever handhold trim	0	at SOP
X69	<b>Carbon door-entry guards</b> With "GT3" logo	0	<b>07/2006</b>

		Product offering	Availability (at SOP = 04/2006)
O = Optional equipment W = Available at no extra charge			
<b>Audio and communication</b>			
P16	<b>Porsche Communication Management (PCM) including navigation module</b> Information and navigation system, comprising 5.8" screen with 12-button keypad, dual-tuner radio with integrated audio CD drive including MP3 playback function, aerial diversity, GPS navigation module with separate DVD drive in front luggage compartment and on-board computer featuring parallel display of basic audio and navigation on dot-matrix instrument cluster, including one navigation DVD covering virtually all of Europe	0	at SOP
666	<b>Telephone module for PCM</b> Triband telephone for GSM 900, 1800 and 1900 networks, for small SIM card, basic functions operated via control stalks on steering column with simultaneous display on instrument cluster, hands-free facility, SMS functions and SOS emergency call button.  Note: Retrofitting more complex than ex-factory installation	0	at SOP
618	<b>Telephone preparation for mobile phone</b> Note: Only in conjunction with CDR-24 radio	0	at SOP
639	<b>Chrono package</b> Comprising analogue stopwatch on the dashboard and digital stopwatch function in the instrument cluster  Note: Not in conjunction with PCM	0	at SOP
640	<b>Chrono Plus package</b> Corresponding to Chrono package, but with performance display in PCM and individual memory for light, wiper, air-conditioning and door-locking settings  Note: Only in conjunction with PCM	0	at SOP
490	<b>Sound Package Plus, including CD storage tray</b> Analogue sound system with total of 9 loudspeakers and 280 W total output, including CD storage tray in glove compartment Dashboard: Two 1.9 cm high-frequency loudspeakers one 7.0 cm mid-frequency loudspeaker (centre speaker) Doors: Two 20.0 cm low-frequency loudspeakers two 10.0 cm mid-frequency loudspeakers Rear: Two 10.0 cm wide-band loudspeakers	0	at SOP
461	<b>Rod antenna</b> For improved medium-wave reception	W	at SOP
<b>Factory collection</b>			
900	<b>Factory collection</b>	0	at SOP
<b>Country-specific offering</b>			
675	<b>Preparation for navigation in Japan</b>	0	at SOP

# 11 Colours

## 11.1 Exterior colours

The customer has a choice of 4 solid colours or, optionally, 6 metallic and 7 special colours for the new 911 GT3. There are no plans to offer colours to sample.

### Solid colours, exterior

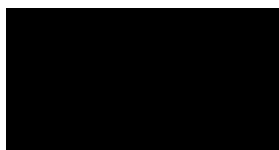

Black



Guards Red

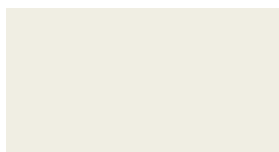

Carrara White



Speed Yellow

\*Available from 08/2006 at the earliest

### Metallic colours – exterior



Basalt Black Metallic



Arctic Silver Metallic



Midnight Blue Metallic

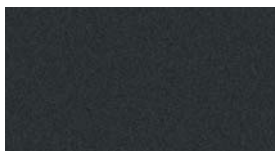

Atlas Grey Metallic



Meteor Grey Metallic\*



Cobalt Blue Metallic\*

### Special colours – exterior

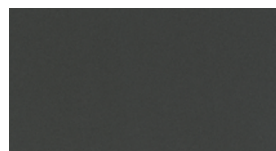

Slate Grey Metallic



GT Silver Metallic



Lapis Blue Metallic



Carmon Red Metallic



Lagoon Green Metallic



Forest Green Metallic

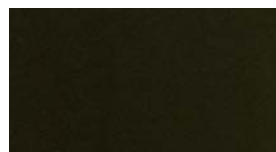

Dark Olive Metallic

## 11.2 Interior colours

As in the 911 GT3 (996), the interior of the new 911 GT3 is always black. A leather interior in black or dark grey natural leather is optionally available. The steering wheel rim, the gearshift lever, the handbrake lever grip and the centre section of the seat are always finished in black Alcantara, both in the basic interior and the interior with leather and seat options. An exception is the optional lightweight bucket seat (P 02), which is upholstered entirely in a black flame-retardant fabric in conjunction with the optional Clubsport package (I 003).

When the leather interior option is ordered, the door handles, door mirrors, door storage compartment lids and console cover are also finished in black Alcantara.

### Standard colours, interior

#### Leatherette/leather/Alcantara <sup>1)</sup>

Interior colour



Black

### Natural leather (optional)

#### Leather/Alcantara

Interior colour



Natural Dark Grey

### Leather colour, interior (optional)

#### Leather/Alcantara <sup>2)</sup>

Interior colour



Black

<sup>1)</sup> In black Alcantara: Roofliner, steering wheel rim, gearshift lever, handbrake lever grip and centre section of seats

<sup>2)</sup> Additionally in black Alcantara: Door handles, door mirrors, door storage compartment lids and centre console cover



Fig. 48: Leather interior dark grey natural leather



## 12 Cost of Ownership

The cost of ownership for the new 911 GT3 is comparable to that for the 911 GT3 (996). Particularly due to its displacement, the new 911 GT3 thus also offers advantages compared to the competition in terms of fuel costs and offers substantial tax advantages in Germany. Maintenance costs and the 3rd party liability insurance classification of the new 911 GT3 are also more favourable than those of many competitors. The table in the appendix provides information on the cost of ownership.

### 12.1 Maintenance intervals

The maintenance intervals of the new 911 GT3 correspond to those of the 911 GT3 (996):

Engine oil	20,000 km
Particle filter	20,000 km
Spark plugs	40,000 km
Oil filter	40,000 km
Air-cleaner element	40,000 km
Fuel filter	80,000 km
Drive belt	80,000 km

### 12.2 Insurance classification

Like the 911 GT3 (996), the new 911 GT3 has been designed to minimise the number of damaged parts in the event of minor accidents.

Corresponding to the current values for the 911 GT3 (996), the new 911 GT3 will probably\* be placed in the same insurance classes. Thanks to the favourable development in damage claims, it was possible to reclassify all 911 GT3 vehicles from type class 20 to type class 18 under 3rd party liability insurance as of 1 October 2002. A fundamental reclassification after the launch of the new 911 GT3 is currently not anticipated.

Overview of type classes for all 911 GT3 vehicles (irrespective of model year)		New 911 GT3 (997) (probably)*	911 GT3 (996)	911 GT3 (996)
			from 1.10.2002	to 9/2002
3rd party liability	KH	18	18	20
Fully comprehensive	VK	34	34**	40
3rd party, fire + theft	TK	32	32**	40

\* The precise definition of the insurance classification for the new 911 GT3 will be made in early 2006.

\*\* Classes for fully comprehensive and for 3rd party, fire + theft insurance were fundamentally restructured on 1 October 2005. In fully comprehensive insurance, the new class 34 is comparable to the old class 40. In 3rd party, fire + theft insurance, the new class 33 is comparable to the old class 40. Accordingly, the 911 GT3 has not only improved in 3rd party liability insurance (from 20 to 18) but also in 3rd party, fire + theft insurance (from 33 to 32) since 1 October 2002.

## 12.3 Overview Cost-of-Ownership

### Cost of Ownership (Cost of ownership, basis Germany)

As per: November 2005

	911 GT3		996		Change	BMW		Dodge	Corvette	Ferrari
	911 GT3	911 GT3	911 GT3	911 GT3		M3 Coupé	M6 Coupé			
<b>Average scheduled maintenance costs</b>										
Maintenance interval (km)	255 €	255 €	200km	200km	<b>0.0%</b>	192 €	118 €	No details	No details	No details
Hourly workshop rate (D)	85 €	85 €	85 €	85 €		25,000 km	25,000 km	No details	15,000 km	20,000 km
Time required for oil service (h)						63 €	63 €	No details	No details	84 €
Time required for minor maintenance (h)	1.7	1.7	1.7	1.7		0.4	0.6	No details	No details	No details
Time required for major maintenance (h)	2.9	2.9	2.9	2.9		4.5	1.6	No details	No details	No details
Avg. costs of materials for scheduled maintenance	121 €	121 €	121 €	121 €	0.0%	4.9	84 €	No details	No details	No details
Avg. labor costs for scheduled maintenance	134 €	134 €	134 €	134 €	0.0%	102 €	34 €	No details	No details	No details
Avg. supplementary maintenance costs	68 €	68 €	68 €	68 €	0.0%	90 €	41 €	No details	No details	No details
<b>Avg. maintenance costs p.a.</b>	<b>323 €</b>	<b>323 €</b>	<b>323 €</b>	<b>323 €</b>	<b>0.0%</b>	<b>35 €</b>	<b>159 €</b>	<b>450 €</b>	<b>400 €</b>	<b>700 €</b>
<b>Avg. motor vehicle tax p.a.</b>	<b>243 €</b>	<b>243 €</b>	<b>243 €</b>	<b>243 €</b>	<b>0.0%</b>	<b>223 €</b>	<b>338 €</b>	<b>560 €</b>	<b>405 €</b>	<b>297 €</b>
Emission classification	EU 4	EU 4	EU 4	EU 4		EU 4	EU 4	EU 3	EU 3/D4	EU 3/D4
<b>Avg. fuel costs p.a.</b>	<b>2,300 €</b>	<b>2,318 €</b>	<b>2,318 €</b>	<b>2,318 €</b>	<b>-0.8%</b>	<b>2,392 €</b>	<b>2,660 €</b>	<b>3,212 €</b>	<b>2,184 €</b>	<b>3,289 €</b>
DIN fuel consumption (liter per 100 km)	12.8	12.9	12.9	12.9	<b>-0.8%</b>	13.4	14.8	19.1	13.0	18.3
Range (km)	685	690	690	690		470	473	366	531	519
<b>Avg. insurance costs p.a.</b>	<b>5,898 €</b>	<b>5,898 €</b>	<b>5,898 €</b>	<b>5,898 €</b>	<b>0.0%</b>	<b>3,789 €</b>	<b>3,722 €</b>	<b>6,361 €</b>	<b>2,450 €</b>	<b>6,361 €</b>
Insurance (3rd party liability/fully comp./3rd party, fire + theft)	18/34/32	18/34/32	18/34/32	18/34/32		20/32/32	18/32/30	25/34/33	17/29/30	25/34/33
<b>Avg. total costs p.a.</b>	<b>8,764 €</b>	<b>8,782 €</b>	<b>8,782 €</b>	<b>8,782 €</b>	<b>-0.2%</b>	<b>6,631 €</b>	<b>6,879 €</b>	<b>10,583 €</b>	<b>5,439 €</b>	<b>10,647 €</b>
<b>Δ-Total costs for 997 GT3</b>	<b>0 €</b>	<b>18 €</b>	<b>18 €</b>	<b>18 €</b>		<b>-2,133 €</b>	<b>-1,885 €</b>	<b>1,819 €</b>	<b>-3,325 €</b>	<b>1,883 €</b>
<b>Overall ranking</b>	<b>4</b>	<b>5</b>	<b>5</b>	<b>5</b>		<b>2</b>	<b>3</b>	<b>6</b>	<b>1</b>	<b>7</b>
<b>Depreciation (after 3 years):</b>										
<b>New car price</b>	93,000 €	88,028 €	88,028 €	88,028 €		48,448 €	93,534 €	90,517 €	68,922 €	119,569 €
<b>Depreciation (per year in €)</b>	14,880 €	14,406 €	14,406 €	14,406 €		9,680 €	17,764 €	15,841 €	11,970 €	11,957 €
<b>Depreciation (per year in %)</b>	16.00%	16.37%	16.37%	16.37%		19.98%	18.99%	17.50%	17.37%	10.00%

The data and values are based on the sources listed below as well as on estimates of VAV8, VAT and EMP1;

all values without VAT and country-specific costs

Avg. annual costs, based on 60,000 km in 4 years

Prices exclusive of VAT



Sources for calculation of total costs: Allianz, ADAC, PET, POSES, Technical data



## 13 Technical data



Data relate to the EU-specification model unless otherwise specified

**Bold** entries Denote points where the new 911 GT3 deviates from the 911 GT3 (1996)



No details No figures available at time of going to press



	Unit	New 911 GT3 (1997)	911 GT3 (1996)	911 GT3 RS (1996)
				
<b>1. Engine</b>				
Number of cylinders		6	6	6
Valves/cylinder		4	4	4
Displacement (effective)	cm <sup>3</sup> / cu. in	3,600 / 219.7	3,600 / 219.7	3,600 / 219.7
Bore x stroke	mm in	100 x 76.4 3.94 x 3.0	100 x 76.4 3.94 x 3.0	100 x 76.4 3.94 x 3.0
Max. output	kW / bhp / hp (EEC)	<b>305 / 415 / 415</b>	280 / 381 / 380	280 / 381 / 380
at engine speed	rpm	<b>7,600</b>	7,400	7,400
Max. torque	Nm / ftlb. rpm	<b>405 / 300</b> <b>5,500</b>	385 / 285 5,000	385 / 285 5,000
at engine speed				
Compression ratio		<b>12.0:1</b>	11.7:1	11.7:1
Volumetric efficiency	kW/l bhp/l	<b>84.7</b> <b>115.3</b>	77.8 105.8	77.8 105.8
Engine cooling (cylinder head)		Cross flow	Cross flow	Cross flow
Engine controller/mixture preparation		Digital engine electronics ME 7.8 <b>enhanced</b>	Digital engine electronics ME 7.8	Digital engine electronics ME 7.8
Fuel type (RON 95 can be used but will reduce performance)		RON 98 unleaded	RON 98 unleaded	RON 98 unleaded
Generator	W	<b>2,100</b>	1,680	1,680
Starter	kW	<b>1.7</b>	1.7	1.7
Battery capacity	Ah	<b>60</b>	60	60
Idle speed	rpm	<b>780 ±40</b>	800 ±40	800 ±40
Maximum engine speed	rpm	<b>8,400</b>	8,200	8,200
<b>2. Transmission</b>				
Manual gearbox	1st gear	3.82	3.82	3.82
Transmission ratio	2nd gear	<b>2.26</b>	2.15	2.15
	3rd gear	<b>1.64</b>	1.56	1.56
	4th gear	<b>1.29</b>	1.21	1.21
	5th gear	<b>1.06</b>	1.00	1.00
	6th gear	<b>0.92</b>	0.85	0.85
Reverse		2.86	2.86	2.86
Final drive ratio, rear axle		3.44	3.44	3.44
Clutch diameter	mm / in	240 / 9.45	240 / 9.45	240 / 9.45

	Unit	New 911 GT3 (997)	911 GT3 (996)	911 GT3 RS (996)
				
<b>3. Chassis</b>				
<b>Front axle</b>		<p><b>PASM chassis.</b> Spring strut suspension, wheels suspended individually on wishbones with trailing links and spring struts, <b>divided control arm (camber adjustment)</b>, Unibal front supporting mount (McPherson type, Porsche-optimised). One cylindrical spring per wheel with progressive characteristic and internal single-tube gas-filled shock absorber <b>Shock absorber with double clamping to the wheel carrier</b></p>	Spring strut suspension, wheels suspended individually on wishbones with trailing links and spring struts, Unibal front supporting mount (McPherson type, Porsche-optimised). One cylindrical spring per wheel with progressive characteristic and internal single-tube gas-filled shock absorber	Spring strut suspension, wheels suspended individually on wishbones with trailing links and spring struts, Unibal front supporting mount (McPherson type, Porsche-optimised). One cylindrical spring per wheel with progressive characteristic and internal single-tube gas-filled shock absorber
Toe-in		<b>+6' (±2')</b>	+8' (±2')	+8' (±2')
Camber		<b>-1°20' (±5')</b>	-50' (±5')	-1° (±5')
<b>Rear axle</b>		<p><b>PASM chassis.</b> Multi-link suspension, wheels supported individually on 5 control arms, <b>control arm divided (adjustable camber)</b>, one cylindrical coil spring per wheel with coaxial internal double-acting hydraulic single-tube gas-filled shock absorber</p>	Multi-link suspension, wheels supported individually on 5 control arms, one cylindrical coil spring per wheel with coaxial internal double-acting hydraulic single-tube gas-filled damper	Multi-link suspension, wheels supported individually on 5 control arms, control arm divided (adjustable camber), one cylindrical coil spring per wheel with coaxial internal double-acting hydraulic single-tube gas-filled shock absorber
Toe-in		+13' (±2')	+13' (±2')	+13' (±2')
Camber		<b>-2° (±5')</b>	-1°50' (±5')	1° (±5')
<b>Steering</b>	Steering ratio	<b>17.1:1 (centre position) up to 13.8:1 (variable)</b>	16.9:1	16.9:1
Steering wheel revolutions from lock to lock		<b>2.62</b>	2.98	2.98
Steering wheel diameter	mm / in	<b>370 / 14.57</b>	375 / 14.76	375 / 14.76

			<b>New 911 GT3 (1997)</b>	<b>911 GT3 (1996)</b>	<b>911 GT3 RS (1996)</b>
		<b>Unit</b>			
					
<b>Brakes</b>			Foot-actuated, hydro-mechanical transmission, 2-circuit brake system, brake booster, 6-piston aluminium monobloc callipers on front axle, 4-piston aluminium monobloc callipers on rear axle, per axle distribution	Foot-actuated, hydro-mechanical transmission, 2-circuit brake system, brake booster, 6-piston aluminium monobloc callipers on front axle, 4-piston aluminium monobloc callipers on rear axle, per axle distribution	Foot-actuated, hydro-mechanical transmission, 2-circuit brake system, brake booster, 6-piston aluminium monobloc callipers on front axle, 4-piston aluminium monobloc callipers on rear axle, per axle distribution
Brake booster			<b>9-inch tandem amplifier</b>	10-inch single amplifier	10-inch single amplifier
ABS			Bosch <b>ABS 8.0</b>	Bosch ABS 5.7	Bosch ABS 5.7
Brake disks - front axle	Type		Internally vented and cross-drilled	Internally vented and cross-drilled	Internally vented and cross-drilled
	Diameter	mm / in	350 / 13.78	350 / 13.78	350 / 13.78
	Thickness	mm / in	34 / 1.34	34 / 1.34	34 / 1.34
Brake disks - rear axle	Type		Internally vented and cross-drilled	Internally vented and cross-drilled	Internally vented and cross-drilled
	Diameter	mm / in	<b>350 / 13.78</b>	330 / 12.99	330 / 12.99
	Thickness	mm / in	28 / 1.10	28 / 1.10	28 / 1.10
Ceramic brake system (PCCB)			Optional extras: Carbon fibre-reinforced ceramic brake discs <b>optimised</b> , internally vented and cross-drilled, 6-piston brake callipers on front axle and 4-piston brake callipers on rear axle, brake disc diameter <b>380 mm front</b> and 350 mm rear, <b>aluminium brake-disc chamber front</b> and stainless-steel brake-disc chamber rear	Optional extras: Carbon fibre-reinforced ceramic brake discs, internally vented and cross-drilled, 6-piston brake callipers on front axle and 4-piston brake callipers on rear axle, brake disc diameter 350 mm front and rear, stainless-steel brake-disc chamber front and rear	Optional extras: Carbon fibre-reinforced ceramic brake discs, internally vented and cross-drilled, 6-piston brake callipers on front axle and 4-piston brake callipers on rear axle, brake disc diameter 350 mm front and rear, stainless-steel brake-disc chamber front and rear
<b>4. Wheels and tyres</b>					
Standard	Wheels	front rear	<b>8.5 J x 19, RO 53</b> <b>12 J x 19, RO 68</b>	8.5 J x 18, RO 40 11 J x 18, RO 63	8.5 J x 18, RO 40 11 J x 18, RO 63
	Tyres	front rear	<b>235/35 ZR19</b> <b>305/30 ZR19</b>	235/40 ZR18 295/30 ZR18	235/40 ZR18 295/30 ZR18
Winter wheels	Wheels	front rear	<b>8 J x 19, RO 57</b> <b>11 J x 19, RO 67</b>	8 J x 18, RO 50 10 J x 18, RO 65	8 J x 18, RO 50 10 J x 18, RO 65
	Tyres	front rear	<b>235/35 R19</b> <b>295/30 R19</b>	225/40 R18 265/35 R18	225/40 R18 265/35 R18
Air pressure, summer wheels	front	partially loaded fully loaded	bar/psi	<b>2.0 / 29.0</b>	2.2 / 32.3
	rear	partially loaded fully loaded	bar/psi	<b>2.1 / 30.5</b>	2.7 / 39.7



	Unit	New 911 GT3 (997)	911 GT3 (996)	911 GT3 RS (996)
				
<b>5. Weights</b>				
Unladen weight acc. to DIN	kg lbs	<b>1,395</b> <b>3,075</b>	1,380 3,042	1,360 2,998
Unladen weight in acc. with EU (DIN + 75 kg driver)	kg lbs	<b>1,470</b> <b>3,241</b>	1,455 3,208	1,435 3,164
Permissible gross weight	kg lbs	<b>1,680</b> <b>3,704</b>	1,660 3,660	1,660 3,660
Max. payload	kg lbs	<b>285</b> <b>629</b>	280 617	300 661
Max. permissible roof load with original Porsche roof transport system	kg lbs	75 165	75 165	75 165
Permissible axle load - front/rear	kg lbs	<b>650 / 1,055</b> <b>1,433 / 2,326</b>	710 / 1,010 1,565 / 2,227	710 / 1,010 1,565 / 2,226
Weight distribution - front/rear	%	38 / 62	38 / 62	38 / 62
<b>6. Performance</b>				
Top speed	km/h mph	<b>310</b> <b>193</b>	306 190	306 190
Acceleration 0-100 km/h	s	<b>4.3</b>	4.5	4.4
Acceleration 0-160 km/h	s	<b>8.7</b>	9.4	9.2
Acceleration 0-200 km/h	s	<b>13.5</b>	14.3	14.0
Acceleration, 0-1,000 m	s	<b>21.0</b>	22.8	22.5
Acceleration, 1/4 mile	s	<b>12.0</b>	12.5	12.3
Flexibility (80-120 km/h) 5th gear	s	<b>6.2</b>	6.5	6.4
<b>7. Fuel consumption/ exhaust emissions</b>				
Manufacturer's specs. in acc. with 80/1268/EEC	Urban Extra-urban Overall l/100 km	<b>19.8</b> <b>8.9</b> <b>12.8</b>	19.9 9.0 12.9	19.9 9.0 12.9
CO <sub>2</sub> emissions Overall	g/km	<b>307</b>	315	315
US fuel consumption combined	mpg	No details	20.7	20.7
<b>8. Exterior dimensions</b>				
Length	RoW USA mm / in	<b>4,447 / 175.08</b> <b>4,481 / 176.42</b>	4,435 / 174.61 4,470 / 175.98	4,435 / 174.61 4,470 / 175.98
Width	without door mirrors with door mirrors mm / in	<b>1,808 / 71.18</b> 1,937 / 76.26	1,770 / 69.69 1,937 / 76.26	1,770 / 69.69 1,937 / 76.26
Height	Standard chassis PASM mm / in	- <b>1,280 / 50.39</b>	1,275 / 50.20 -	1,275 / 50.20 -
Wheelbase	mm / in	2,355 / 92.72	2,355 / 92.72	2,355 / 92.72

		<b>Unit</b>	<b>New 911 GT3 (1997)</b>	<b>911 GT3 (1996)</b>	<b>911 GT3 RS (1996)</b>
					
Track, front	18" 19"		- <b>1,497 / 58.94</b>	1,488 / 58.58 -	1,488 / 58.58 -
Track, rear	18" 19"		- <b>1,524 / 60.00</b>	1,488 / 58.58 -	1,488 / 58.58 -
Drag coefficient	$C_d$		<b>0.29</b>	0.30	0.30
Frontal area A	$m^2$		<b>2.00</b>	1.95	1.95
Drag	$C_d \times m^2$		<b>0.580</b>	0.585	0.585
Turning circle	m / ft		<b>10.9 / 35.8</b>	10.6 / 34.8	10.6 / 34.8
Front entry angle to gradient (with spoiler lip)	Basic PASM	degrees	- <b>5.6</b>	6.0 -	6.0 -
Departure angle	Basic PASM	degrees	- <b>11.1</b>	13.0 -	13.0 -
Ramp angle	Basic PASM	degrees	- <b>10.3</b>	10.5 -	10.5 -
Ground clearance*	Basic PASM	mm / in	- <b>93 (3.66)</b> <b>Underbody lining</b> 911 GT3 (1997) front	70 / 2.8 - Brake air deflector on 911 GT3 (1996) to front control arm	70 / 2.8 - Brake air deflector on 911 GT3 (1996) to front control arm
<b>9. Interior dimensions</b>					
Interior length <sup>1)</sup>	Driver side Passenger's side	mm	<b>1,097</b> <b>974</b>	1,084 973	1,084 973
Shoulder room, front		mm	1,308	1,308	1,308
Elbow room, front		mm	<b>1,355</b>	1,356	1,356
Effective headroom, front		mm	<b>974</b> (without sunroof)	975 (without sunroof)	975 (without sunroof)
Luggage compartment volume	- front	l / imp. gal / US gal	<b>105 / 23.1</b> <b>/ 27.7</b>	110 / 24.2 / 29.1	110 / 24.2 / 29.1
	- rear	l / imp. gal / US gal	<b>205 / 45.1</b> <b>/ 54.2</b>	200 / 44 / 53	200 / 44 / 53
Tank capacity LHD (RHD/USA)		l imp. gal US gal	<b>90 (66/67)</b> <b>19.8 (14.5/14.7)</b> <b>23.8 (17.4/17.7)</b>	89 (64/63) 19.6 (14.1/13.9) 23.5 (16.9/16.6)	89 (64/63) 19.6 (14.1/13.9) 23.5 (16.9/16.6)

<sup>1)</sup> Driver's side: Acceleration point pressed clutch pedal to rear lower H point of the front seat  
Passenger's side: Heel point to lower rear H-point of the front seat

# 14 Core competition

## 14.1 External car comparison

Criterion	Porsche new 911 GT3 (1997)	BMW M3 Coupé (new)	BMW M3 Coupé (current)	BMW M6 Coupé	Ferrari F430	Dodge Viper SRT-10 Coupé	Corvette Z06 Coupé
Model note	new 911 GT3 (1997)	New model: expected series production Mid-2007	Current model	Current model	Current model	Current model	Current model
<b>1. Concept</b>							
<b>Body form</b>	Coupé	Coupé	Coupé	Coupé	Coupé	Coupé	Coupé
<b>Engine position/drive</b>	Rear/rear	Front/rear	Front/rear	Front/rear	Mid engine/rear	Front/rear	Front/rear
<b>Seats/doors</b>	2/2	5/2	5/2	2+2/2	2/2	2/2	2/2
<b>2. Engine</b>							
<b>Type/valves</b>	<b>Horizontally opposed</b> Otto-engine, 24 valves, two overhead camshafts per cylinder bank Continuous intake camshaft adjustment VarioCam, variable intake system with 2 tuning flaps, Aluminium engine block and cylinder head, Nikasil coated bores, Forged pistons, Titanium connecting rods, Forged and plasma-nitrided crankshaft	Otto V-engine, 32 valves, two overhead camshafts per cylinder bank Variable valve control through M double vanos, Electronically controlled throttle (EDR) Engine block in bedplate construction made of aluminium-silicon alloy with cast iron inlays, Aluminium cylinder head, Aluminium pistons and forged steel connecting rods, Forged crankshaft	In-line Otto engine, 24 valves Variable valve control through M double vanos, Electronically controlled throttle (EDR) Engine block in bedplate construction made of aluminium-silicon alloy with cast iron inlays, Aluminium cylinder head, Aluminium pistons and forged steel connecting rods, Forged crankshaft	Otto V-engine, cylinder angle 90°, 40 valves, two overhead camshafts per cylinder bank Variable valve control through M double vanos, Electronically controlled throttle (EDR) Engine block in bedplate construction made of aluminium-silicon alloy with cast iron inlays, Aluminium cylinder head, Aluminium pistons and forged steel connecting rods, Forged crankshaft	V-Otto-Motor. Cylinder angle 90°, 32 valves, two overhead camshafts per cylinder bank Continuous intake and exhaust camshaft adjustment, adjustable resonance intake system Engine block made of aluminium alloy and age-hardened silicon, with wet pressed in cylinder liners with Nikasil coating. Aluminium cylinder head	Otto V-engine, 20 valves, one centre camshaft (OHV) No camshaft adjustment Aluminium engine block with cast iron liners, Aluminium alloy cylinder head	Otto V-engine, 16 valves, one centre camshaft (OHV) No camshaft adjustment Aluminium engine block with steel liners, Cast aluminium pistons, Aluminium cylinder head with titanium intake and sodium-filled exhaust valve, Titanium connecting rods, Forged crankshaft
<b>Cylinder/displacement in cm<sup>3</sup></b>	<b>B6</b> /3,600	V8/4,400	R6/3,246	V10/4,999	V8/4,308	V10/8,275	V8/7,011
<b>Bore x stroke mm</b>	100.0 x 76.4	V8/4,400	87.0 x 91.0	92.0 x 75.2	92.0 x 81.0	102.4 x 100.6	104.8 x 101.6
<b>Max. power output in kW/bhp at stated rpm</b>	305/415 @ 7,600	294/400	252/343 @ 7,900	373/507 @ 7,750	360/490 @ 8,500	372/506 @ 5,600	373/507 @ 6,200
<b>Max. torque in Nm at stated rpm</b>	405 @ 5,500	No details	365 @ 4,900	520 @ 6,100	465 @ 5,250	712 @ 4,200	644 @ 4,800

Criterion	Porsche new 911 GT3 (997)	BMW M3 Coupé (new)	BMW M3 Coupé (current)	BMW M6 Coupé	Ferrari F430	Dodge Viper SRT-10 Coupé	Corvette Z06 Coupé
Max. engine speed	8,400	8,000	7,900	8,250	8,500	6,000	6,800
Specific output in kW/1 (bhp/1)	<b>84.7 (115.3)</b>	71.1 (96.6)	77.6 (105.7)	74.6 (101.4)	83.6 (113.7)	45.0 (61.1)	53.3 (72.3)
Specific torque in Nm/1	112.5	113.6	112.4	104.0	108.0	86.0	91.9
Power-to-weight ratio in acc. with DIN (kg/bhp)	4.57 (3.36)	No details	5.93 (4.36)	4.59 (3.37)	4.0 (3.0)	4.2 (3.1)	3.8 (2.8)
Compression	12.0:1	No details	11.5:1	12.0:1	11.3:1	9.6:1	11.0:1
Fuel grade	Premium plus, 98 RON	Premium plus, 98 RON (Premium 95 RON also usable)	Premium plus, 98 RON	Premium plus, 98 RON	Premium 95 RON	Regular RON 91	Premium plus, 98 RON
Engine management	ME 7.8 advanced development	No details	MSS 54	MS S65 (High-performance in-house development)	ME 7	No details	No details
Engine lubrication	Dry-sump lubrication <b>with 7 oil pumps</b> and external engine oil tank	No details	Forced-feed	Forced-feed with 4 oil pumps with lateral force controlled oil supply	Dry sump lubrication with 4 oil pumps	Forced-feed	Dry sump lubrication
Mixture preparation	Sequential multipoint fuel injection	No details	Multipoint fuel injection	Fuel injection	Fuel injection	Sequential multipoint fuel injection	Sequential fuel injection
Ignition	Single-plug ignition, cylinder-selective knock control	Single-plug ignition, knock control	Single-plug ignition, knock control	Single-plug ignition with ionic current knock control	Single-plug ignition, knock control	Dual ignition	Single-plug ignition
Exhaust system	Twin-branch 3-way catalytic converter exhaust system with one silencer, sports exhaust system	No details	3-way catalytic converter	Stainless steel high-performance manifold 4 tri-metal coated catalytic converters	Exhaust manifold with pre-catalytic converters, 4-in-1 schema, connected to monolith catalytic converters with low number of cells	Four 3-way catalytic converters with heated Lambda probes	2 catalytic converters, exhaust flap system
Emission classification	EU4	EU4	EU4	EU4	EU4	EU3	EU4
CO <sub>2</sub> - Emissions in g/km	<b>307</b>	No details	323	357	420	463	No details
Fuel consumption (average) in accordance with 80/1268/EEC	<b>12.8</b>	No details	13.4	14.8	18.3	19.4	13.0
Acceleration 0-100 km/h	4.3	No details	5.2	4.6	4.0	3.9	3.9
Maximum speed in km/h	310	No details	250 [limited]	250 [limited]	315	306	319
Torque or power kit	Sport button to increase torque in the medium rpm range by up to 25 Nm	No details	Not available	Power button for full power characteristics 507 bhp (basic program with 400 bhp)	Not available	Not available	Not available

Criterion	Porsche new 911 GT3 (997)	BMW M3 Coupé (new)	BMW M3 Coupé (current)	BMW M6 Coupé	Ferrari F430	Dodge Viper SRT-10 Coupé	Corvette Z06 Coupé
<b>3. Transmission</b>							
<b>Manual transmission</b>	6-speed with double-mass flywheel, <b>steel synchronization rings and interchangeable transmission ratios</b> , Additional oil cooler	7-speed; sequential manual transmission (SMG) incl. automatic mode	6-speed; optional: sequential M transmission (DriveLogic SMG II) incl. automatic mode	7-speed; sequential manual transmission (SMG) incl. automatic mode. Additional oil cooler	6-speed; optional: F1-shifting incl. automatic mode	6-speed manual transmission	6-speed manual transmission with single-mass flywheel (EMS)
<b>Automatic transmission</b>	Not available	Not available (see also manual transmission)	Not available (see also manual transmission)	Not available (see also manual transmission)	Not available (see also manual transmission with F1 shifting)	Not available	Not available
<b>4. Chassis</b>							
<b>Front axle</b>	Spring strut axle, wheels suspended individually on control arms with trailing links and spring struts, Unibal front support bearing (McPherson type, Porsche-optimized).	No details	Single-joint spring strut axle with negative wheel cadtor offset; small positive scrub radius; transverse force compensation; brake diving reduction	Two-joint spring strut axle with tension strut, adapted suspension strut, wheel carrier and front axle carrier	Forged aluminium double control arms with unequal length	Upper and lower cast aluminium triangular control arm	Double triangular control arms, cast aluminium upper and lower control arms
<b>Rear axle</b>	Multi-link suspension (LSA system), wheels suspended individually on 5 control arms	No details	Central control arm axle with trailing links and double control arm; start and brake diving compensator	Aluminium integral axle with trailing links and double control arm; start and brake diving compensator	Forged aluminium double control arms with unequal length	Cast aluminium upper and lower triangular control arm, "Toe control" struts	Double triangular control arms, cast aluminium upper and lower control arms
<b>Springs/dampers/anti-roll bars</b>	Front: one cylindrical spring per wheel with progressive characteristic, with internal PASM damper; rear: one coil spring per wheel with coaxial internal PASM damper; <b>vehicle height, toe, camber and anti-roll bar individually adjustable for race circuits</b>	No details	Coil springs front and rear, anti-roll bars front and rear, conventional dampers	EDC (Electronic damper control) with 3 choices per press of the button (sport, comfort and normal) to adjust damper force, anti-roll bar and coil spring front and rear, active wheel suspension	FA & RA: Coil spring with internal adaptive damper (active chassis)	Front (FA): Coil springs, low pressure gas-filled shock absorbers, anti-roll bars; rear (RA): Coil springs, low pressure gas-filled shock absorbers, anti-roll bar	FA & RA: Composite material transverse leaf springs, single-tube shock absorbers
<b>Steering</b>	Rack-and-pinion power steering	Rack-and-pinion steering with speed-dependent power steering (Servotronic)	Rack-and-pinion power steering	Rack-and-pinion steering with speed-dependent power steering (Servotronic)	Rack-and-pinion power steering with speed-dependent assistance	Rack-and-pinion power steering	Rack-and-pinion power steering, speed-dependent
<b>Variable steering ratio</b>	<b>Standard</b>	Not available	Not available	Not available	Not available	Not available	Not available
<b>Turning circle (in m)</b>	10.9	No details	11.0	12.4	10.8	12.3	No details



Criterion	Porsche new 911 GT3 (997)	BMW M3 Coupé (new)	BMW M3 Coupé (current)	BMW M6 Coupé	Ferrari F430	Dodge Viper SRT-10 Coupé	Corvette Z06 Coupé
<b>Driving dynamics control/systems for improving traction</b>	Asymmetric locking differential (28/40%) at rear axle; Traction Control (TC) incl. ABD, ASR and MSR	No details	Cornering brake control (CBC), Automatic stability control + traction (ASC+T), Dynamic stability control (DSC III), Dynamic brake control (DBC), M Differential lock	DSC (Dynamic stability control) that can be switched off with selection function MDM (M Dynamic mode) as well as variable M differential lock rear	CST (Stability and traction control), E-diff at RA, to be operated as packages in conjunction with gearshift times and damper hardness through "Manettino", electronic brake distribution (EBD)	Dana 44-4 Hydra-Lok locking differential	ESP and electronic traction control
<b>Braking system</b>	Internally vented and perforated brake discs Front: 350 x 34 mm Rear: 350 x 28 mm  Aluminium-Monobloc fixed callipers: Front: 6 pistons Rear: 4 pistons Anti-lock braking system (ABS) 8.0	No details	Internally vented and perforated compound brake discs: Front: 325 mm Rear: 328 mm  1-piston floating calliper	Internally vented and perforated compound brake discs: Front: 374 x 36 mm Rear: 370 x 24 mm  2-piston floating calliper	Internally vented and perforated brake discs: Front: 330 x 32 mm Rear: 330 x 32 mm  4-piston fixed callipers	Internally vented brake discs: Front: 355 x 32 mm Rear: 355 x 32 mm  4-piston fixed callipers	Internally vented and perforated brake discs: Front: 355 x 32 Rear: 340 x 26  Front: 6-piston fixed callipers Rear: 4-piston fixed callipers Anti-lock braking system (ABS)
<b>Ceramic brake system</b>	Optional: Porsche Ceramic Composite Brake (PCCB); internally vented and perforated brake discs Front: 380 x 34 mm Rear: 350 x 28 mm Aluminium-Monobloc fixed callipers: Front: 6 pistons Rear: 4 pistons	No details	Anti-lock braking system (ABS) Dynamic stability control (DSC) Dynamic brake control (DBC)	Anti-lock braking system (ABS) Dynamic stability control (DSC) Dynamic brake control (DBC)	Anti-lock braking system (ABS)	Anti-lock braking system (ABS)	Not available
<b>Wheel size (front/rear)</b>	8.5 J x 19 RO 53 12 J x 19 RO 68	No details	8 J x 18 with asymmetric humps 9 J x 18 with asymmetric humps	8.5 J x 19 RO 12 9.5 J x 19 RO 17	7.5 J x 19 10 J x 19	10 J x 18 13 J x 19	9.5 J x 18 12 J x 19
<b>Tyre size (front/rear)</b>	235/35 ZR 19 305/30 ZR 19	No details	225/45 ZR 18 255/40 ZR 18	255/40 ZR 19 285/35 ZR 19	225/35 ZR 19 285/35 ZR 19	275/35 ZR 18 345/30 ZR 19	275/35 ZR 18 325/30 ZR 19
<b>Tyre type</b>	Sports tyres	No details	Standard tyres	Standard tyres	Standard tyres	Standard tyres	Standard tyres
<b>Tire Pressure Monitoring (TPM)</b>	Optional	No details	Flat indicator	Flat indicator	Optional	Standard	Standard

Criterion	Porsche new 911 GT3 (1997)	BMW M3 Coupé (new)	BMW M3 Coupé (current)	BMW M6 Coupé	Ferrari F430	Dodge Viper SRT-10 Coupé	Corvette Z06 Coupé
<b>5. Exterior</b>							
<b>Exterior colors</b>	4 solid colors, optional: 6 metallic and 7 special colors	No details	3 solid colors, optional: 5 metallic colors, custom colors	1 solid color, 6 metallic colors, optional: custom colors	16 metallic/solid colors, optional: choice of special paints and colors (except for red and yellow)	4 metallic/solid colors	4 solid colors, 2 metallic colors
<b>Door mirror</b>	Heated, electrically adjustable. Passenger side aspherical	No details	Electrically adjustable (memory function), heating optional: electrically retractable	Heated, electrically adjustable, painted in vehicle color, aspherical, with retraction function, automatic dimming	Heated and electrically adjustable	Single-arm door mirror in vehicle color	Single-arm door mirror in vehicle color, heated
<b>Roof system</b>	Optional: Electric slide/tilt sunroof	No details	Optional: Electric glass slide/tilt sunroof	Not available	Not available	Not available	Not available
<b>Aerodynamic package</b>	Front apron with spoiler lip and additional opening for exhaust airflow from radiator. <b>2 ram air boxes on rear lid, fixed rear wing</b>	No details	Rear spoiler	Special design of front and rear apron in CFRP	Downforce producing aerodynamics through front spoiler, underbody, diffuser and rear spoiler	Form and underbody design for lower $c_d$ Value	Front and rear apron especially designed for the Z06 as well as additional air intakes and outlets provide reduced lift. Front fenders, wheel housings and base plate made of CFRP
<b>Glazing/sun-screening</b>	Heat-insulating glass tinted green all around Optional: Windscreen with grey top tint	No details	Heat-insulating glass tinted green all around Optional: Windscreen with green top tint	Heat-insulating glass, green, all around	Heat-insulating glass all around	No details	No details
<b>Parking aid</b>	Not available	No details	Optional: Park Distance Control (with acoustic distance alarm at rear)	Optional: Park Distance Control at front and rear with visual and acoustic indication	Not available	Not available	Not available
<b>Key system</b>	Vehicle key with integrated remote control	No details	Vehicle key with integrated remote control	Vehicle key with integrated remote control also for rear lid	Vehicle key with integrated remote control	Keyless entry	Standard keyless access

Criterion	Porsche new 911 GT3 (997)	BMW M3 Coupé (new)	BMW M3 Coupé (current)	BMW M6 Coupé	Ferrari F430	Dodge Viper SRT-10 Coupé	Corvette Z06 Coupé
<b>6. Interior</b>							
<b>Interior colors</b>	1 interior color (black); optional: 1 Natural leather color (dark grey)	No details	2 interior colors, 1 standard upholstery/leather color, 1 partial leather color and 5 additional full-leather upholstery colors, 5 interior trim colors	1 interior color, 3 standard upholstery colors and 2 additional full-leather upholstery colors, 4 interior trim colors, optional: Custom colors	12 leather and 8 carpet colors	1 interior color (black)	3 interior colors
<b>Material design</b>	<b>Seat centre section as well as steering wheel, shift lever, parking brake lever in Alcantara finish:</b> high-quality surfaces; optional: Leather interior, natural leather and additional leather options; optional: color belts, exterior colors and carbon packages; <b>Club sports package without extra costs (in conjunction with light-weight bucket seats with highly flame-retardant material): Roll cage, 6-point belts in red with fire extinguisher added</b>	No details	Seat fabric impulse/Nappa leather, M-steering wheel, shift lever knob and handbrake handle in leather; optional: Seats in partial/full leather	Leather interior Merino (seats, centre console, parking brake handle boot, arm rest, door handles), leather steering wheel, aluminium, wood or piano laquer mouldings; optional: Roofliner in Alcantara finish; optional: Full-leather interior incl. roofliner in Alcantara finish	Leather interior: Seats, door panels, dashboard, rear centre console, steering wheel, parking brake handle; Carbon or aluminium centre console and dashboard elements; optional: Seat design "Daytona" (perforated leather), additional leather and color options; roll-over bar, 4-point belts, fire extinguisher	Seats as well as selected components in leather	Seats as well as steering wheel in leather
<b>Seats</b>	Leather seats incl. thorax airbag with mechanical reach and height adjustment as well as electrical backrest adjustment; optional: Adaptive sports seats without memory optional: Lightweight bucket seats in CFRP with Alcantara centre section	No details	M Sports seats, backrest mesh on front seats, height-adjustable driver/passenger seat, electric seat adjustment for driver and passenger with memory function for driver seat	M sports seats with electric backrest adjustment, lumbar support and backrest width adjustment for driver and passenger, memory function for driver	Electrically adjustable sports seats; optional: Seat design "Daytona"; optional: Manually adjustable bucket seats in CFRP	Leather seats	Leather seats, electrically adjustable on driver side in 6 directions
<b>Heated seats/steering wheel</b>	Optional seat heating for sports seats	No details	Optional	Heated seats standard	Not available	Not available	Optional: Seat heating

Criterion	Porsche new 911 GT3 (997)	BMW M3 Coupé (new)	BMW M3 Coupé (current)	BMW M6 Coupé	Ferrari F430	Dodge Viper SRT-10 Coupé	Corvette Z06 Coupé
<b>7. Heating and air conditioning</b>							
<b>Air conditioning</b>	Automatic air conditioning with integrated activated charcoal filter	No details	Automatic climate control incl. micro-filter, automatic recirculation control (AUC) and solar sensor	Automatic climate control, active carbon filter, automatic recirculation control (AUC), fogging and solar sensor and memory	Electronically controlled air conditioner	Manual air conditioner	Dual-zone air conditioner with interior filter
<b>8. Electrics, audio &amp; communication</b>							
<b>Standard lights</b>	Clear-glass halogen main headlights with projector-type	No details	Halogen main headlights	Bi-Xenon headlights with headlight washer system, optional adaptive cornering light	Bi-Xenon headlights incl. high-pressure cleaning system	Xenon (HID high intensity discharge)	Xenon headlight
<b>Headlights featuring gas discharge technology</b>	Optional: Bi-Xenon lighting system	No details	Optional: Bi-Xenon lighting system	Standard	Standard	Standard	Standard
<b>Fog lights</b>	Standard	No details	Standard	Not available	Not available	Standard	Standard
<b>Theft protection</b>	Alarm system with interior surveillance and immobilizer standard; optional: <b>Vehicle Tracking System fixture</b>	No details	Immobiliser EWSII; optional: Alarm system	Alarm system with remote control, electronic immobilizer (EWS), hazard warning lights, tilt alarm and emergency power siren standard	Alarm system and immobilizer standard	Alarm system	Immobilizer and alarm system with visual and acoustic alarm
<b>Automatically adjustable interior/door mirrors with integrated rain sensor</b>	Optional	No details	Rear-view mirror with automatic dimming function; optional: Rain sensor with automatic driving light activation	Standard	Not available	Not available	Optional: Automatic dimming
<b>Multi-Functional Steering Wheel</b>	Not available	No details	Standard	Standard	Manettino & Start button	Not available	Not available
<b>Audio/radio</b>	CD radio CDR-24		Optional: BMW Business/ BMW Professional Radio	CD radio with hifi loudspeaker system; optional: CD-Radio BMW-Professional	CD radio	AM/FM radio with integrated 6-disc CD changer. 310 Watt (RMS) amplifier and 7 loudspeakers	AM/FM radio with CD/MP3 drive. RDS and 7 loudspeakers
<b>Sound systems</b>	4 wide-band speakers; optional: Sound Package Plus with 9 loudspeakers	No details	Optional: Harman/kardon loudspeaker system	Optional: Surround professional LOGIC7 hifi system with 13 loudspeakers	Optional: HiFi sound system with subwoofer	Not available	BOSE® Sound system with integrated 6-disc CD changer
<b>CD changer</b>	Not available	No details	Optional: 6-disc (MP3-capable)	Optional: 6-disc changer in glove compartment	Optional: 6-disc CD changer	Standard	Optional (in conjunction with BOSE®)
<b>Navigation system</b>	Optional: PCM with navigation	No details	Optional: Navigation system Business	Optional: Navigation system Professional incl. Radio Professional, 8.8" Color monitor, split-screen, voice input, DVD data in addition; optional: TV tuner	Optional: 1-DIN Radio navigation system	Not available	Optional: In conjunction with Premium audio system navigation

Criterion	Porsche new 911 GT3 (997)	BMW M3 Coupé (new)	BMW M3 Coupé (current)	BMW M6 Coupé	Ferrari F430	Dodge Viper SRT-10 Coupé	Corvette Z06 Coupé
Telephone	Optional: Telephone preparation for CDR-24; optional: Telephone module for PCM	No details	Optional	Optional: Mobile phone preparation incl. hands-free facility and voice control	Optional: Bluetooth hands-free facility	Not available	Not available
Headup display	Not available	No details	Not available	Optional	Not available	Not available	Standard; Track mode and G-Meter
Chrono Plus package	Optional	No details	Not available	Not available	Not available	Not available	Not available
<b>9. Safety</b>							
Driver/passenger airbag	Standard	No details	Standard	Standard	Standard	Standard	Standard
Side airbags	Standard (Thorax airbag)	No details	Standard	Standard	Not available	Not available	Optional
Curtain/window airbags	Standard (head airbag)	No details	Standard at front	Standard	Not available	Not available	Standard
Side impact protection	Standard	No details	Standard	Standard	Standard	Not available	Not available
Belt-force limiters front/rear	Standard at front	No details	Standard at front	Standard at front	Standard at front	No details	No details
Belt tensioners front/rear	Standard at front	No details	Standard at front	Standard	Standard at front	No details	No details
<b>10. Dimensions and weights</b>							
Wheelbase (mm)	<b>2,355</b>	No details	2,731	2,781	2,600	2,510	2,629
Exterior dimensions (L x W x H in mm)	4,447 x 1,808 x 1,280	No details	4,492 x 1,780 x 1,372	4,871 x 1,855 x 1,372	4,512 x 1,923 x 1,214	4,459 x 1,911 x 1,234	4,445 x 1,930 x 1,244
Weight (DIN, empty)	<b>1,395</b>	No details	1,495	1,710	1,450	1,547	1,420
Weight (EC, empty)	1,470	No details	1,570	1,785	1,525	1,622	1,495
Permissible gross weight	1,680	No details	2,000	2,200	1,720	No details	No details
Max. payload	285	No details	505	490	270	No details	No details
Aerodynamics (c <sub>x</sub> x A)	0.29 x 2.00 = 0.58	No details	0.688	0.32 x 2.15 = 0.69	No details	0.39 x 1.79 = 0.70	0.31
Tank capacity	90 (RHD: 66 (USA: 67))	No details	63	70	95	70	68
Range (km)	<b>703</b> (RHD: <b>516; USA: 523</b> )	No details	470	473	519	361	523
Luggage compartment capacity in l	105	No details	410	450	250	180	634
<b>11. Warranty coverage and prices</b>							
Warranty period	2 years	No details	2 years	2 years	2 years	3 years / 36,000 miles	3 years / 36,000 miles
Guarantee against rusting through	3 years	No details	12 years	12 years	2 years	5 years / 100,000 miles	6 years / 100,000 miles
Paintwork guarantee	3 years	No details	3 years	3 years			
RRP incl. 16% VAT (D)	€ 108,061	No details	€ 56,200	€ 108,500	€ 138,700	€ 105,000 (Roadster price)	€ 79,950

Specifications on competitor vehicles are based on sales documentation, press releases as well as information from the dealerships and branch offices. No responsibility is taken for the correctness of this information.



## 14.2 Key product merits

Note: The comparison with the competition relates to the respective EU models (Dodge Viper SRT-10 and Corvette Z06 are the respective US models). The information on competitor vehicles is based on sales literature, press reports and information from retail outlets and branches. Accuracy cannot be guaranteed.

### 14.2.1 Key advantages of the new 911 GT3 over the current BMW M3 Coupé

As no adequate information on the new BMW M3 Coupé was available at the time of drawing up this overview (start of series production expected in mid-2007), this comparison with the competitor vehicle was carried out on the basis of the current M3 Coupé.



Fig. 49: BMW M3

#### Engine/performance

- Light 6-cylinder horizontally opposed rear-mounted engine for:
  - Low vehicle weight and low vehicle centre of gravity
  - High performance and agility
  - Good traction
- Better performance through:
  - Higher maximum power output (incl. specific output / volumetric efficiency)
  - Better power-to-weight ratio
  - Better maximum torque
  - Higher revving
- Dry sump lubrication for reliable oil supply on race circuits, too
- Lower fuel consumption and lower exhaust emissions (CO<sub>2</sub>)
- Better acceleration from 0-100 km/h
- Higher top speed
- Sport button for torque boost in middle rev range to improve acceleration

<b>Chassis</b>	<ul style="list-style-type: none"> <li>• Variable PASM damper system for direct handling incl. minimal rolling tendency for high cornering speeds, particularly in race circuit use</li> <li>• Camber, toe and anti-roll bar adjustable for race circuit use</li> <li>• Wider and larger wheels and sports tyres for improved traction and road holding and more agile cornering</li> <li>• 6-piston brake callipers on front axle and 4-piston brake callipers on rear axle for high braking performance</li> <li>• Larger brake disks on the rear axle for high braking performance</li> <li>• Optional PCCB for further enhanced braking performance</li> <li>• Smaller turning circle for practicality in daily use</li> <li>• Variable steering ratio for high tracking stability and direct handling in bends</li> </ul>
<b>Exterior</b>	<ul style="list-style-type: none"> <li>• Broader choice of exterior colours for customisation</li> <li>• Better <math>c_d \times A</math> value for higher speeds and lower fuel consumption</li> </ul>
<b>Interior</b>	<ul style="list-style-type: none"> <li>• Steering wheel, gearshift and handbrake lever in Alcantara for better grip, particularly in racing use</li> <li>• Optional lightweight carbon-fibre plastic bucket seats for high lateral support and low vehicle weight</li> <li>• Clubsport package as no cost option for enhanced safety, e.g. in race circuit use</li> <li>• Optional Chrono Plus package incl. evaluation of driving data in PCM</li> </ul>
<b>Electrics, audio and communication</b>	<ul style="list-style-type: none"> <li>• Alarm system incl. interior surveillance as standard</li> </ul>
<b>Safety</b>	<ul style="list-style-type: none"> <li>• High-performance brake system</li> <li>• Optional vehicle tracking system for enhanced protection against theft</li> </ul>
<b>Dimensions and weights</b>	<ul style="list-style-type: none"> <li>• More dynamic performance due to markedly lower vehicle weight</li> <li>• More agile cornering behaviour due to smaller wheelbase</li> <li>• Better visibility due to compact vehicle length</li> <li>• High range due to large fuel tank</li> </ul>

**14.2.2 Key advantages of  
the new 911 GT3 over the  
BMW M6 Coupé**



Fig. 50: BMW M6 Coupé

<p><b>Engine/performance</b></p>	<ul style="list-style-type: none"> <li>• Lightweight 6-cylinder horizontally opposed rear-mounted engine for: <ul style="list-style-type: none"> <li>- Low vehicle weight and low vehicle centre of gravity</li> <li>- High performance and agility</li> <li>- Good traction</li> </ul> </li> <li>• Better performance through: <ul style="list-style-type: none"> <li>- Better power-to-weight ratio</li> <li>- Higher revving</li> </ul> </li> <li>• Dry sump lubrication with 3 additional oil pumps for reliable oil supply on race circuits, too</li> <li>• Lower fuel consumption and lower exhaust emissions (CO<sub>2</sub>)</li> <li>• Better acceleration from 0-100 km/h</li> <li>• Higher top speed</li> </ul>
<p><b>Chassis</b></p>	<ul style="list-style-type: none"> <li>• Wider wheels and tyres on the rear axle for better traction</li> <li>• Sports tyres for better traction, better road holding and more agile cornering</li> <li>• Camber, toe and anti-roll bar adjustable for race circuit use</li> <li>• 6-piston brake callipers on front axle and 4-piston brake callipers on rear axle for high braking performance</li> <li>• Optional PCCB for further enhanced braking performance</li> <li>• Small turning circle for practicality in daily use</li> <li>• Variable steering ratio for high tracking stability and direct handling in bends</li> </ul>
<p><b>Exterior</b></p>	<ul style="list-style-type: none"> <li>• Broader choice of exterior colours for customisation</li> <li>• Better <math>c_d \times A</math> value for higher speeds and lower fuel consumption</li> <li>• Optional sunroof for greater personalisation</li> </ul>
<p><b>Interior</b></p>	<ul style="list-style-type: none"> <li>• Steering wheel, gearshift and handbrake lever in Alcantara for better grip, particularly in racing use</li> <li>• Optional lightweight carbon-fibre plastic bucket seats for high lateral support and low vehicle weight</li> <li>• Clubsport package as no cost option for enhanced safety, e.g. in race circuit use</li> <li>• Optional Chrono Plus package incl. evaluation of driving data in PCM</li> </ul>
<p><b>Safety</b></p>	<ul style="list-style-type: none"> <li>• High-performance brake system</li> <li>• Optional vehicle tracking system for enhanced protection against theft</li> </ul>
<p><b>Prices, dimensions and weights</b></p>	<ul style="list-style-type: none"> <li>• More dynamic performance due to markedly lower vehicle weight</li> <li>• More agile cornering behaviour through a smaller wheelbase</li> <li>• Better visibility due to compact vehicle length</li> <li>• High range due to large fuel tank</li> </ul>

### 14.2.3 Key advantages of the new 911 GT3 over the Ferrari F430



Fig. 51: Ferrari F430

<b>Engine/performance</b>	<ul style="list-style-type: none"> <li>• Lightweight 6-cylinder horizontally opposed rear-mounted engine for: <ul style="list-style-type: none"> <li>- Low vehicle weight and low vehicle centre of gravity</li> <li>- High agility</li> <li>- Good traction</li> </ul> </li> <li>• Dry sump lubrication with 3 additional oil pumps for reliable oil supply on race circuits, too</li> <li>• Markedly lower fuel consumption and markedly lower exhaust emissions (CO<sub>2</sub>)</li> <li>• Sport button for torque boost in middle rev range to improve acceleration</li> </ul>
<b>Chassis</b>	<ul style="list-style-type: none"> <li>• Wider wheels and sports tyres on the front and rear axle for better traction, better road holding and more agile cornering</li> <li>• Camber, toe and anti-roll bar adjustable for race circuit use</li> <li>• Sports tyres for better traction, better road holding and more agile cornering</li> <li>• 6-piston aluminium brake callipers on front axle for high braking performance</li> <li>• Larger brake disks on the front and rear axles for high braking performance</li> <li>• Variable steering ratio for high tracking stability and direct handling in bends</li> </ul>
<b>Exterior</b>	<ul style="list-style-type: none"> <li>• Optional sunroof for high level of personalisation</li> </ul>
<b>Interior</b>	<ul style="list-style-type: none"> <li>• Steering wheel, gearshift and handbrake lever in Alcantara for better grip, particularly in racing use</li> <li>• Clubsport package as no cost option for enhanced safety, e.g. in race circuit use</li> <li>• Optional Chrono Plus package incl. evaluation of driving data in PCM</li> <li>• Larger range of customisation options (e.g. automatically dimming interior and door mirrors, rain sensor, heated seats, cruise control)</li> </ul>
<b>Electrics, audio and communication</b>	<ul style="list-style-type: none"> <li>• Optional PCM with navigation based on map display</li> </ul>
<b>Safety</b>	<ul style="list-style-type: none"> <li>• High-performance brake system</li> <li>• Optional vehicle tracking system for enhanced protection against theft</li> <li>• Side airbags</li> </ul>
<b>Prices, dimensions and weights</b>	<ul style="list-style-type: none"> <li>• Lower-priced vehicle</li> <li>• More dynamic handling due to low vehicle weight</li> <li>• Agile cornering through a smaller wheelbase</li> <li>• Better visibility due to compact vehicle length</li> <li>• Higher payload</li> <li>• High range due to lower fuel consumption</li> </ul>

**14.2.4 Key advantages of  
the new 911 GT3 over the  
Dodge Viper SRT-10 Coupé**



fig. 52: Dodge Viper SRT-10 Coupé

<p><b>Engine/performance</b></p>	<ul style="list-style-type: none"> <li>• Lightweight 6-cylinder horizontally opposed rear-mounted engine for: <ul style="list-style-type: none"> <li>- Low vehicle weight and low vehicle centre of gravity</li> <li>- High performance and agility</li> <li>- Good traction</li> </ul> </li> <li>• High revving capability for high performance</li> <li>• Dry sump lubrication for reliable oil supply on the race circuit, too</li> <li>• Overhead camshafts, 4-valve cylinder heads and VarioCam for high engine performance combined with substantially lower fuel consumption and lower exhaust emissions (CO<sub>2</sub>)</li> <li>• Higher top speed</li> <li>• Sport button for torque boost in middle rev range to improve acceleration</li> </ul>
<p><b>Chassis</b></p>	<ul style="list-style-type: none"> <li>• Variable PASM damper system for direct handling incl. minimal rolling tendency for high cornering speeds, particularly in race circuit use</li> <li>• Camber, toe and anti-roll bar adjustable for race circuit use</li> <li>• Sports tyres for better traction, better road holding and more agile cornering</li> <li>• 6-piston aluminium brake callipers on front axle for high braking performance</li> <li>• Cross-drilled brake disks for good response and high braking performance in wet conditions, too</li> <li>• Optional PCCB for further enhanced braking performance</li> <li>• Small turning circle for practicality in daily use</li> <li>• Variable steering ratio for high tracking stability and direct handling in bends</li> </ul>
<p><b>Exterior</b></p>	<ul style="list-style-type: none"> <li>• Broader choice of exterior colours for customisation</li> <li>• Better <math>c_d \times A</math> value for higher speeds and lower fuel consumption</li> </ul>
<p><b>Interior</b></p>	<ul style="list-style-type: none"> <li>• Steering wheel, gearshift and handbrake lever in Alcantara for better grip, particularly in racing use</li> <li>• Greater number of interior colours (dark grey natural leather) for customisation</li> <li>• Optional lightweight carbon-fibre plastic bucket seats for high lateral support and low vehicle weight</li> <li>• Clubsport package as no cost option for enhanced safety, e.g. in race circuit use</li> <li>• Optional Chrono Plus package incl. evaluation of driving data in PCM</li> <li>• Additional customisation options (e.g. automatically dimming interior and door mirrors, rain sensor, heated seats)</li> </ul>
<p><b>Electrics, audio and communication</b></p>	<ul style="list-style-type: none"> <li>• Optional PCM with navigation based on map display</li> <li>• Optional telephone</li> </ul>

<b>Safety</b>	<ul style="list-style-type: none"><li>• High-performance brake system</li><li>• Traction Control</li><li>• Optional vehicle tracking system for enhanced protection against theft</li><li>• Side airbags</li></ul>
<b>Dimensions and weights</b>	<ul style="list-style-type: none"><li>• More dynamic performance due to markedly lower vehicle weight</li><li>• More agile cornering behaviour through a smaller wheelbase</li><li>• Better visibility due to compact vehicle length</li><li>• High range due to large fuel tank and low fuel consumption</li></ul>



**14.2.5 Key advantages of the new 911 GT3 over the Corvette Z06**



Fig. 53: Corvette Z06

<p><b>Engine/performance</b></p>	<ul style="list-style-type: none"> <li>• Lightweight 6-cylinder horizontally opposed rear-mounted engine for: <ul style="list-style-type: none"> <li>- Low vehicle weight and low vehicle centre of gravity</li> <li>- High agility</li> <li>- Good traction</li> </ul> </li> <li>• High revving capability for high performance</li> <li>• Overhead camshafts, 4-valve cylinder heads and VarioCam for high engine performance combined with substantially lower fuel consumption and lower exhaust emissions (CO<sub>2</sub>)</li> <li>• Dual-mass flywheel for enhanced driving comfort</li> <li>• Sport button for torque boost in middle rev range to improve acceleration</li> </ul>
<p><b>Chassis</b></p>	<ul style="list-style-type: none"> <li>• Variable PASM damper system for direct handling incl. minimal rolling tendency for high cornering speeds, particularly in race circuit use</li> <li>• Coil springs on front and rear axles for more agile handling</li> <li>• Camber, toe and anti-roll bar adjustable for race circuit use</li> <li>• Sports tyres for better traction, better road holding and more agile cornering</li> <li>• Larger brake disks on the rear axle for high braking performance</li> <li>• Optional PCCB for further enhanced braking performance</li> <li>• Variable steering ratio for high tracking stability and direct handling in bends</li> </ul>
<p><b>Exterior</b></p>	<ul style="list-style-type: none"> <li>• Broader choice of exterior colours for customisation</li> <li>• Better c<sub>d</sub> value for higher speeds and lower fuel consumption</li> </ul>
<p><b>Interior</b></p>	<ul style="list-style-type: none"> <li>• Steering wheel, gearshift and handbrake lever in Alcantara for better grip, particularly in racing use</li> <li>• Optional lightweight carbon-fibre plastic bucket seats for high lateral support and low vehicle weight</li> <li>• Clubsport package as no cost option for enhanced safety, e.g. in race circuit use</li> <li>• Optional Chrono Plus package incl. evaluation of driving data in PCM</li> </ul>
<p><b>Electrics, audio and communication</b></p>	<ul style="list-style-type: none"> <li>• Optional PCM with navigation based on map display</li> <li>• Optional telephone</li> </ul>
<p><b>Safety</b></p>	<ul style="list-style-type: none"> <li>• Optional vehicle tracking system for enhanced protection against theft</li> <li>• Side airbags as standard</li> </ul>
<p><b>Dimensions and weights</b></p>	<ul style="list-style-type: none"> <li>• More dynamic handling due to lower vehicle weight</li> <li>• More agile cornering behaviour through a smaller wheelbase</li> <li>• Better visibility due to compact vehicle length</li> <li>• High range due to large fuel tank</li> </ul>

### 14.3 Overview of USPs

The following comparison has been drawn up to the best of our knowledge and belief on the basis of the product features presented above, the official sales literature and information from the Porsche development department, and includes a subjective evaluation.

Accuracy cannot be guaranteed.

This overview offers ideas for presenting selling points in discussions with customers.

	New Porsche 911 GT3	Competitors					Customer benefits
		BMW M3 (current model)	BMW M6	Ferrari F430	Dodge Viper SRT-10	Corvette Z06	
<b>Engine</b>							+ Very good/better than the competition 0 Good/on a par with the competition - Unfavourable/inferior to the competition + Best in class/superior to the competition
Engine type, number of cylinders	<b>B6</b>	R6	V10	V8	V10	V8	Six-cylinder horizontally opposed engine with minimum vibration and a low vehicle centre of gravity for good traction, agility and high driving dynamics
Rear or mid engine	+	0	0	+	0	0	Very good traction through high weight on the driving axle
High engine speed concept	+	0	0	+	-	-	High maximum power. Agile acceleration in conjunction with short transmission ratio
Specific output (kW/l)	+	0	0	0	-	-	High specific output shows the efficiency of an engine featuring a combination of high power, low weight and low fuel consumption
Sport button for increased torque	+	0	+	0	0	0	Sport button to boost torque in the middle rev range for improved acceleration
Dry sump lubrication	+	0	0	+	0	+	Ensures that the engine is lubricated even during high lateral and longitudinal acceleration, with 7 oil pumps
Fuel consumption	+	0	0	-	-	-	Low fuel consumption for low cost of ownership
Exhaust emissions (CO <sub>2</sub> )	+	0	0	-	-	-	Reduced pollution and reduced cost of ownership through tax savings in Germany

	New Porsche 911 GT3	Competitors					Customer benefits
		BMW M3 (aktuelles Modell)	BMW M6	Ferrari F430	Dodge Viper SRT-10	Corvette Z06	
							+ Very good/better than the competition 0 Good/on a par with the competition - Unfavourable/inferior to the competition + Best in class/superior to the competition
<b>Transmission</b>							
Additional transmission cooling	+	0	+	0	0	0	Ensures stability of components even when transmission is subject to maximum loads
Steel synchroniser rings	+	0	0	0	0	0	Ensure component stability and wear resistance, even when transmission is subjected to high shifting stress
Interchangeable transmission ratios	+	0	0	0	0	0	Selection of an individual transmission ratio at motor racing events
<b>Chassis</b>							
Active sports chassis (PASM)	+	0	+	+	-	-	High driving stability and high driving dynamics incl. lateral acceleration potential in combination with high practicality in daily use
Vehicle height, camber, toe and anti-roll bar adjustable	+	0	0	0	0	0	Individual chassis set-up for motor racing events
Wide sports tyres	+	0	0	0	0	0	High traction during acceleration and braking. High lateral acceleration potential. Exact handling and steering
Short wheelbase	+	0	0	0	0	0	Agile handling and cornering
Variable steering ratio	+	0	0	0	0	0	High agility and good handling on winding stretches of road combined with high driving stability at high speeds
<b>Brake system</b>							
Multi-piston fixed calliper brake system with large brake disks	+	-	0	0	0	+	High-performance brake system incl. 6-piston fixed callipers on front axle with high braking potential, fading stability and driving safety
PCCB ceramic brake system (optional)	+	-	-	+	-	-	Minimal unsprung masses for high driving dynamics and excellent potential for coping with high levels of stress
<b>Exterior</b>							
Aerodynamics with adjustable rear wing	+	0	-	0	-	-	Aerodynamics geared to racing needs, with downforce and low drag for high driving stability and high top speed. Additionally adjustable rear wing for individual vehicle tuning at motor racing events
Range of exterior colours	+	0	0	+	-	-	Broad scope for customisation

	New Porsche 911 GT3	Competitors					Customer benefits
		BMW M3 (aktuelles Modell)	BMW M6	Ferrari F430	Dodge Viper SRT-10	Corvette Z06	
							+ Very good/better than the competition 0 Good/on a par with the competition - Unfavourable/inferior to the competition + Best in class/superior to the competition
<b>Interior</b>							
Alcantara material concept	+	0	0	0	0	0	High-quality and functional finishes on the control elements steering wheel, gearshift lever and handbrake lever
Lightweight carbon-fibre plastic bucket seats	+	0	0	+	0	0	Option for weight reduction and racing-oriented seat quality incl. lateral support
Clubsport package	+	0	0	0	0	0	No cost option for high passive safety and eligibility criterion for motor racing events requiring official clearance
Chrono (Plus) package	+	0	0	0	0	0	Option for measuring lap times incl. individual evaluation of driving data in PCM (Chrono Plus package)
Vehicle Tracking System	+	0	0	0	0	0	Option for enhanced protection against theft
<b>Overview</b>							
Performance/driving dynamics	+	0	0	+	0	0	Excellent lateral and longitudinal acceleration potential
Top speed	+	-	-	+	0	+	High performance
Vehicle weight	+	0	-	0	-	0	Low vehicle weight for agile handling and high driving dynamics
Vehicle centre of gravity	+	0	-	+	0	0	Low vehicle position and 6-cylinder horizontally opposed engine with low vehicle centre of gravity for high driving dynamics
Compact vehicle dimensions	+	0	-	0	0	+	Compact vehicle dimensions for high agility, good handling and good visibility
Range	+	0	0	0	-	-	High range due to large fuel tank and low fuel consumption



## **Imprint**

Confidential!

This training document is intended solely for internal use within the Porsche sales information.

Note:

All information provided in this document is correct as at 12/2005. Porsche reserves the right to alter design, technical specification, prices, equipment and final scope of delivery at any time prior to the market launch of the 911 GT3.

The descriptions in this section are based on the EU model. Country-specific changes are possible up to the launch and throughout the service life of the vehicle.

Edition: 12/2005

© Dr. Ing. h.c. F. Porsche  
Aktiengesellschaft  
Marketing- und Verkaufstraining (VO4)  
Porschestraße 15-19  
71634 Ludwigsburg

Printed in Germany.

Errors and amendments excepted.





