

ORCIARI®

Porsche 996/Boxster (tutte le versioni)
(all version)



PAGINA 1 di 5
PAGE 1 of 5

COPPIA COPRISEDILI ANATOMICI
anatomycal seat covers

COD: 00366



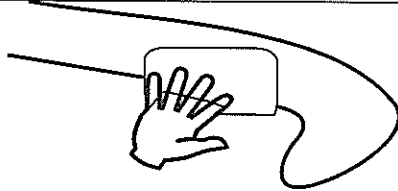
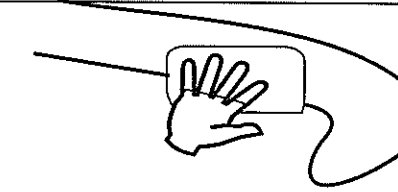
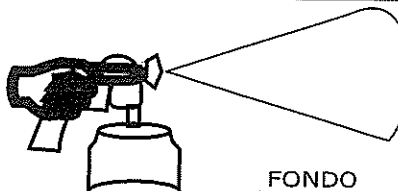

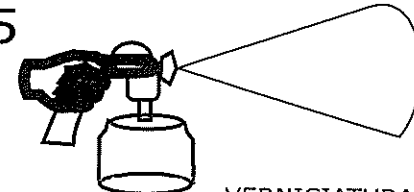
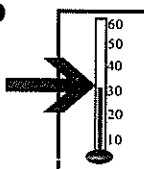

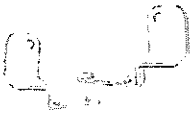

Istruzioni di montaggio Fitting instructions

PREPARAZIONE E VERNICIATURA/ PRIMING AND PAINTING

<p>1</p>  <p>CARTA ABRASIVA GRANA 320</p>	<p>2</p>  <p>CARTA ABRASIVA GRANA 400</p>	<p>3</p>  <p>FONDO PER ABS</p>
<p>4</p>  <p>CARTA ABRASIVA GRANA 400</p>	<p>5</p>  <p>VERNICIATURA</p>	<p>6</p>  <p>ESSICATURA VERNICE MAX +30° GRADI C</p>

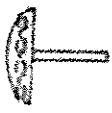
N.B. La superficie nera del copri sedile è da considerarsi grezza, e per ciò da sottoporre ai trattamenti di carteggiatura e verniciatura sopra indicati.

P.S. The black surface of the seat covers is a raw surface and therefore sand paper treatment and painting are requested, as indicated on top of this page.

<p>A</p>  <p>2</p> <p>Coppie staffe</p>	<p>B</p>  <p>2</p> <p>Coppia cuscini per spalle</p>	<p>C</p>  <p>8</p> <p>Vite allu. 6ma x 15</p>	<p>D</p>  <p>4</p> <p>Piastrina 5 viti</p>
<p>E</p>  <p>4</p> <p>Falsa vite</p>	<p>F</p>  <p>8</p> <p>Vite autof.T.S.B.2,9*19 ZN NERE</p>	<p>G</p>  <p>4</p> <p>Fischer per falsavite</p>	<p>H</p>  <p>28</p> <p>Vite tc+ 2.2x6,5</p>
<p>I</p>  <p>2</p> <p>Targhetta logo</p>			

ORCIAARI®

Porsche 996/Boxster (tutte le versioni)
(all version)

PAGINA 3 di 5
PAGE 3 of 5

COPPIA COPRISEDILI ANATOMICI
anatomycal seat covers

COD: 00366

Istruzioni di montaggio *Fitting instructions*

- Remove the lever used to lift the seat from its housing by pulling towards the outside (see **picture nr. 1.**)
- Remove the plastic guide by pulling first towards the outside and then downwards see **picture nr 2.**
- Insert accessory **A** in the lateral housing, turn it until its holes are in the same position of the internal seat iron (see **picture nr. 3.**)
- position the holes in corrispondence to the metallic structure of the seat, mark their position using drill diameter 6mm. Remove the plate and make the holes with drill diameter of 2mm, afterwards insert again the plate as previously explained, and fix it with screw **F** (see **picture nr.4.**)
- Unscrew the peg behind the headrest (see **picture nr. 5.**)
- Insert the seat covers with a slight pressure downwards (see **picture nr.6.**)
- Insert cushions for shoulders **B** in the respective housing. (See **picture nr 7.**)
- Fix the cushions **B** by screwing the screws **C** in the proper holes, on the back of the seat covers, corresponding to the sholders area (see **picture 8.**)
- Using the drill diameter 6mm make holes in connection with the housing placed in the low parts of the seat covers, (see **picture nr.9**)
- Inside the holes, insert the fisher **G** and then accessory **E** (see **picture 10.**)
- Screw the peg behind the headrest, using the original screw (see **picture nr.11**)
- Insert the accessory **D** in the proper housing be carefull that the hole is placed upwards.
- After having maked with drill of 6mm the points where to make the holes, remove accessory **D** and make the holes with drill of 2mm. Apply the accessory **D** and fix it with screws **H**(see **picture nr,12.**)
- Position the plate **I** at 35mm from the lower base of the peg, mark the cover seat in correspondence of the holes with drill of 6mm, than remove the plate and make the holes with drill of 2mm. Insert the plate and fix it with screws **H**(see **picture nr. 13**)
- Reinsert the lever used to lift the seat on its housing pressing towards the seat (see **picture nr.14.**)

Fig.1

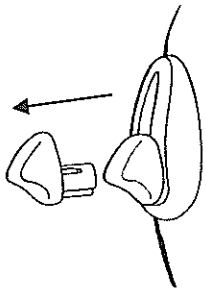

Fig.2

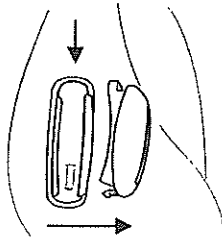

Fig.3

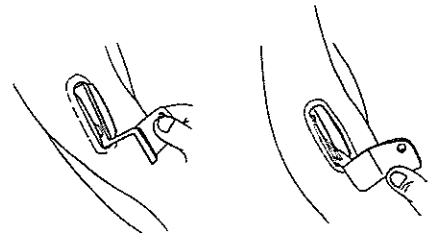

Fig.4

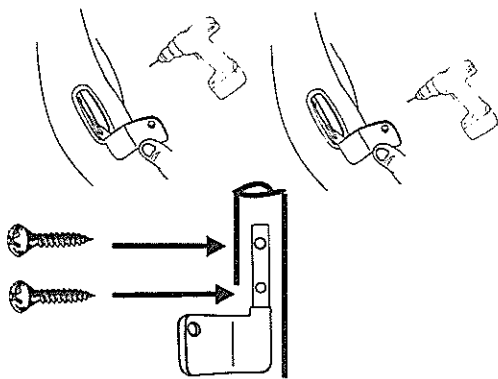

Fig.5

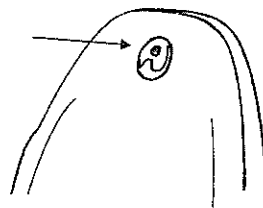

Fig.6

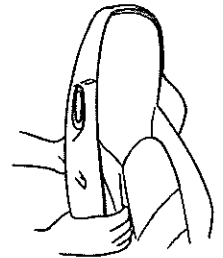

Fig.7



Fig.8

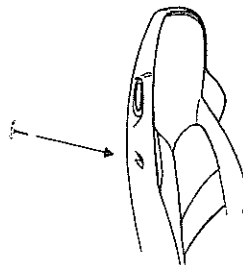
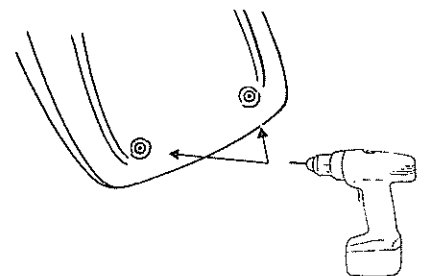

Fig.9



Porsche 996/Boxster (tutte le versioni)
(all version)

PAGINA 5 di 5
PAGE 5 of 5

COPPIA COPRISEDILI ANATOMICI
ANATOMICAL SEAT COVERS

COD: 00366

Fig.10

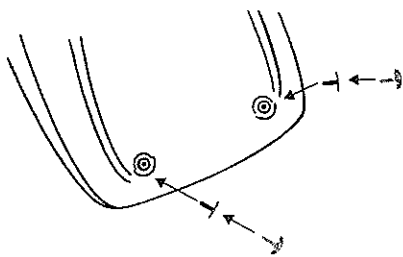

Fig.11

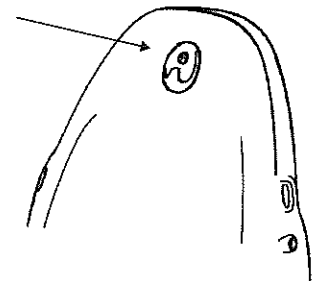

Fig.12



Fig.13

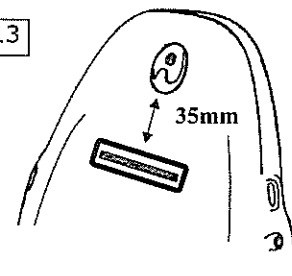

Fig.14

