

2.5 Install TECHART rear spoiler II

i After crimping, heat up all crimp connectors using a hot air gun so that they form a watertight seal.

- 1 Open service lid (for convertibles: set the convertible-top compartment into service position) and dismantle.
- 2 Detach the original rear spoiler (7) from the carrier.

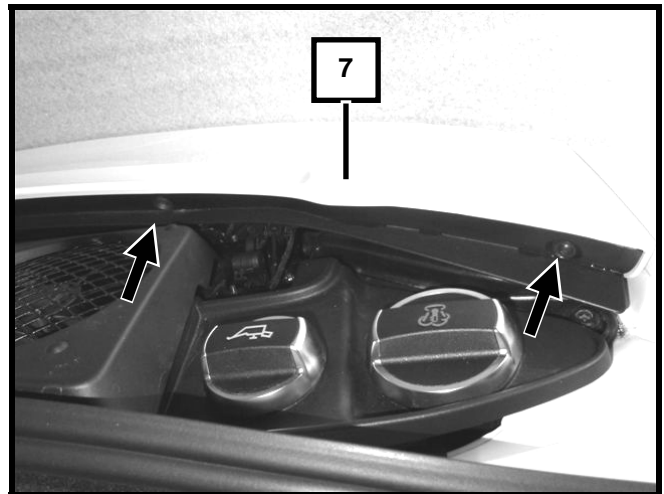

Fig. 20

- 3 Dismantle the center stop light incl. clip from the rear spoiler carrier.
- 4 Detach the original rear spoiler carrier (10).

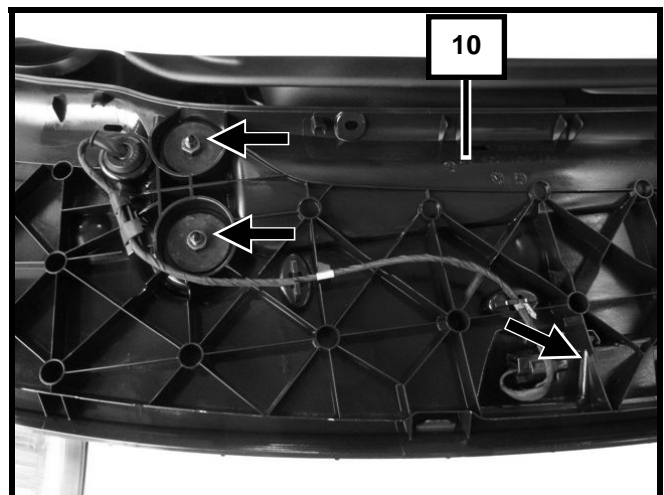

Fig. 21



ASSEMBLY INSTRUCTIONS

TECHART Aerokit for 991 Carrera

- 5 Fasten the TECHART rear bracket 091.100.810.300 (11) with both center screws of the rear apron.

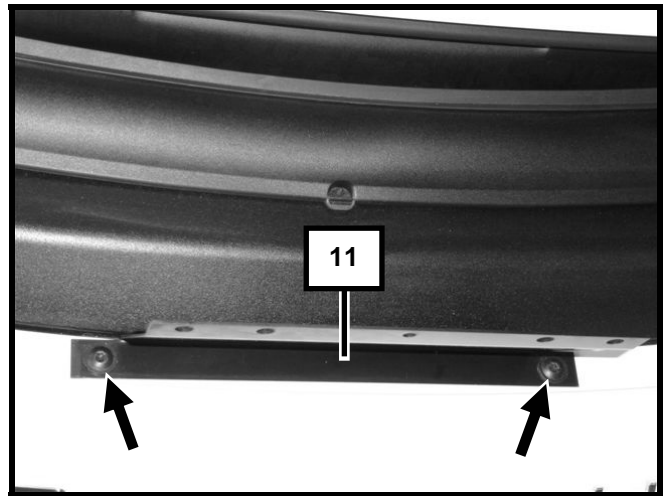

Fig. 22

- 6 Bolt the TECHART bracket for the center stop light 091.100.810.301 (12) with the screws 5x16 to the TECHART base frame hood 091.100.810.101 (13).

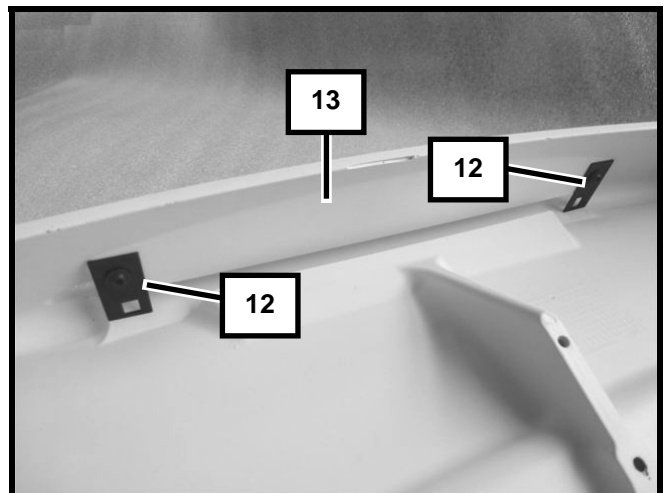

Fig. 23

- 7 Tighten the TECHART bracket front top 091.100.810.311 (14a) with the screws M5x16 to the TECHART base frame (15).
- 8 Tighten the TECHART bracket front top (14b) with the screws M5x10 to the TECHART bracket front bottom (14a).

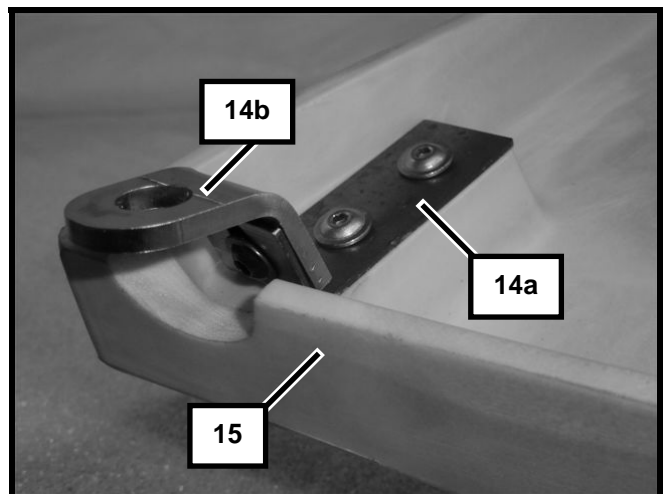

Fig. 24



ASSEMBLY INSTRUCTIONS

TECHART Aerokit for 991 Carrera

- 9 Bolt the TECHART base frame hood (13) with the screws M5x16 and the washers black 12.0/6.2/2.0 to the TECHART base frame (15).

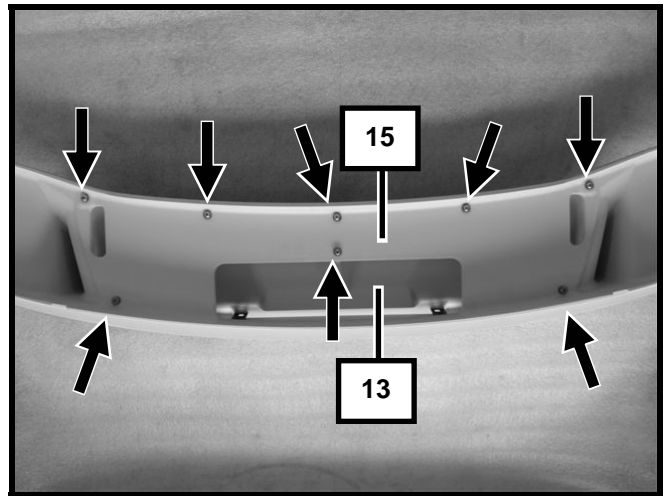

Fig. 25

- i** Alternatively you can install the short or the long bases.
For convertibles: only the short bases are possible!

Short bases:

- 10 Set the TECHART short base 091.100.810.210/211 (17) on to the TECHART base frame (15) and tighten with the screws M8x90 (18) into the TECHART base frame (15).

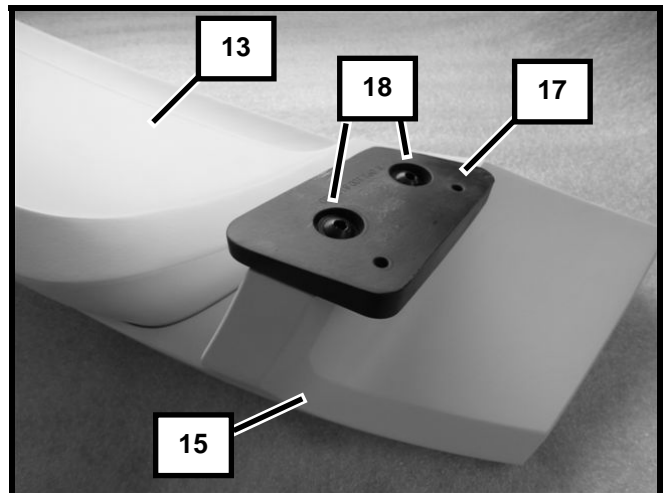

Fig. 26

Long bases:

- 11 Set the TECHART long base 091.100.810.220/221 (19) and 091.100.810.220/221 (20) onto the TECHART base frame (15) and tighten with the screws M8x90 (18) into the TECHART base frame (15).

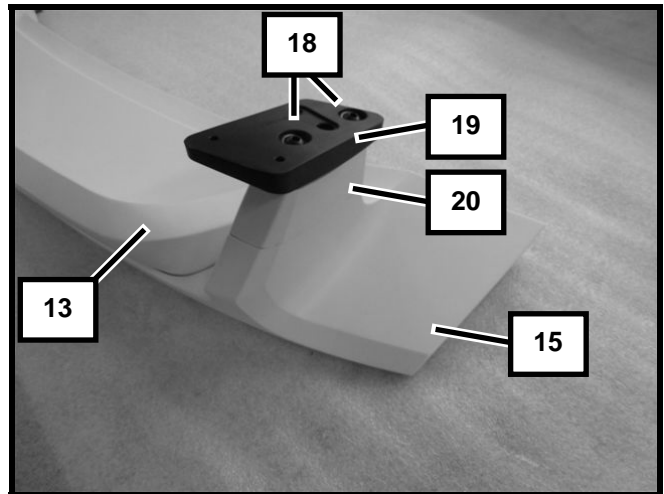

Fig. 27

- 12 Unscrew the fastening screws front left and right from the complete rear spoiler drive.
- 13 Route and fit the wiring harness of the center stop light into the TECHART rear spoiler (15) and fasten it at the TECHART front bracket (14) with the original screws to the complete rear spoiler drive.

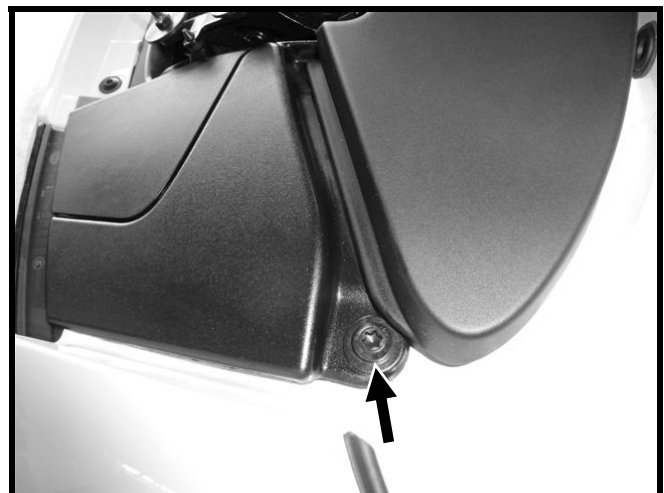

Fig. 28

- 14 Bolt the TECHART rear bracket (11) with the screws 5x10 into the TECHART rear spoiler hood (13).

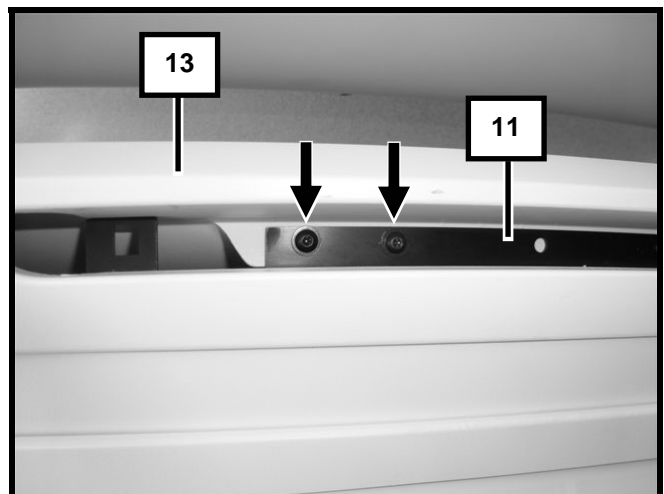



Fig. 29

 Care for an accurate fit.



ASSEMBLY INSTRUCTIONS

TECHART Aerokit for 991 Carrera

Short bases:

- 15 Bolt the TECHART wing profile 091.100.810.200 (21) with the screws M5x16 to the TECHART short base (17).

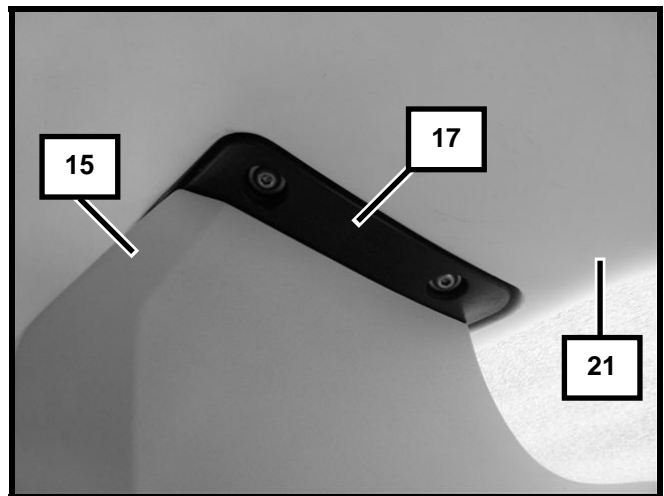

Fig. 30

Long bases:

- 16 Bolt the TECHART wing profile 091.100.810.200 (21) with the screws M5x16 to the TECHART long base (19).

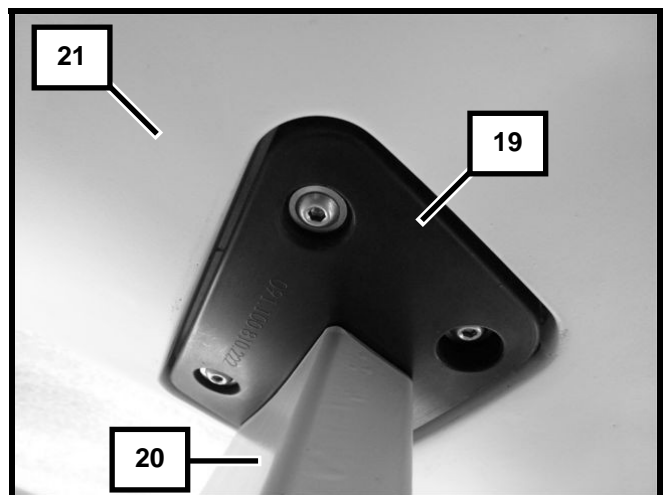

Fig. 31

- 17 Clip the fixing clip 99950758401 of the center stop light into the TECHART stop light bracket (12).
- 18 Slide the sleeve 95555958600 onto the bracket of the center stop light.
- 19 Connect the center stop light electronically and clip into the TECHART base frame hood.
- 20 Unscrew and unclip the three louvers incl. the center high-mounted stop light from the inside.
- 21 Unclip the center high-mounted stop light from the louvers.

Coupe:

- 22 Route the wiring harness of the center high-mounted stop light to the plug of the rear spoiler (right maintenance area). For that turn the rubber grommet in the panel sheet, see arrow.

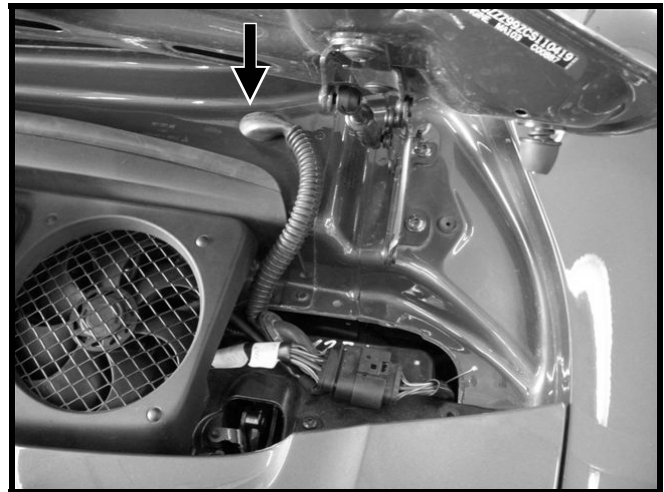

Fig. 32

Convertible:

- 23 Dismantle the wiring harness of the center high-mounted stop light from the convertible-top compartment and route to the plug of the rear spoiler (right maintenance area).



Fig. 33

- 24 Separate the cable black/red Pin 4 about 20 mm in front of the 14-fold plug.
- 25 The ending towards the vehicle stays free. Insulate well.
- 26 Connect the cable black/red of the wiring harness from the center high-mounted stop light and the black/red cable from the plug with the red crimp connector.

- 27 Clip in the louvers again.
- 28 Stick the decal for the center stop light 091.100.810.500 (21) to the center high-mounted stop light.
- 29 Clip in the TECHART center high-mounted stop light, without the electrical connection.

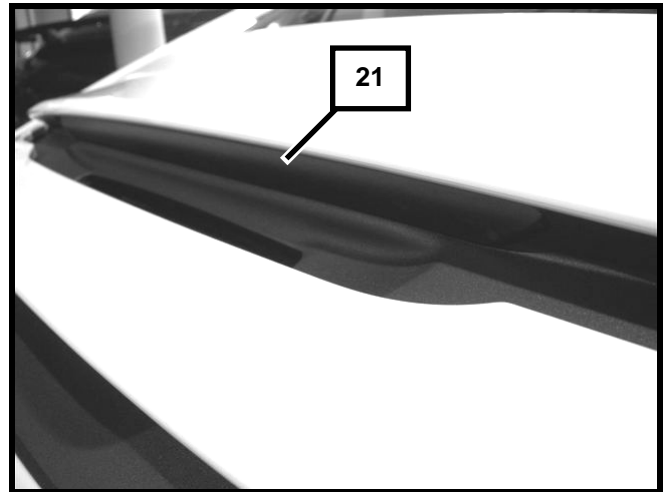

Fig. 34

- 30 Recode the vehicle with the PIWIS to fixed rear spoiler.
 - Rear-end electronics
 - Coding adaptations
 - Manual coding
 - Aerokit Cup / ON!!!



For vehicles with sunroof:

With an open roof and a speed over 160km/h the multifunctional display shows the information: "close roof"

3 Final check

- 1 Perform a general function check on vehicle. Check the illumination.