

DISASSEMBLY OF MAGNETIC CLUTCH

1. REMOVE PRESSURE PLATE

(a) Using SST and a socket, remove the shaft nut.
SST 07110-77010



(b) Using SST and socket, remove the pressure plate.
SST 07112-71010



(c) Remove the shims from the shaft.



2. REMOVE ROTOR

- (a) Using SST, remove the snap ring.
SST 07114-84020

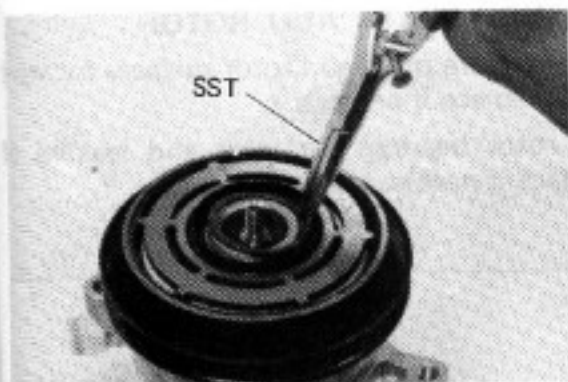

- (b) Using a plastic hammer, tap the rotor off the shaft.
CAUTION: Be careful not to damage the pulley when tapping the rotor.

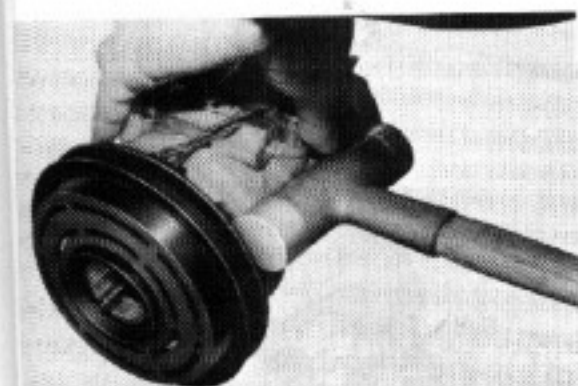
**3. REMOVE STATOR**

- (a) Disconnect the stator lead wires from the compressor housing.

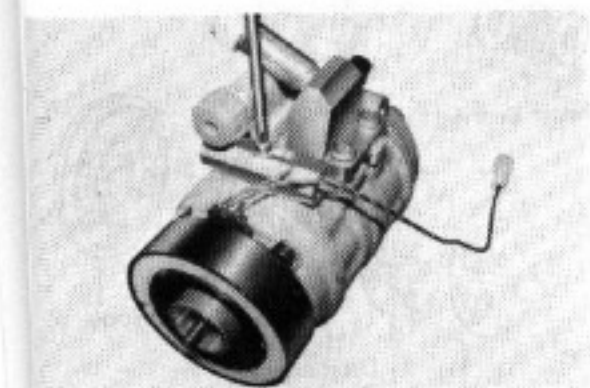

- (b) Using SST, remove the snap ring. Remove the stator.
SST 07114-84020

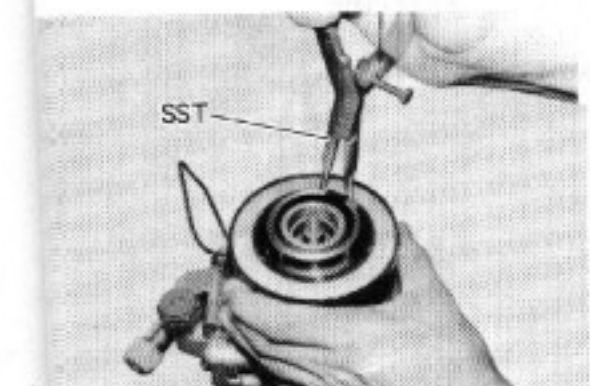
**4. REMOVE ROTOR BEARINGS**

NOTE: Press the bearings out only if they are to be replaced.

- (a) Remove the bearing snap ring from the rotor.
(b) Using SST, press out the two bearings.
SST 07110-77011



5. INSPECT PRESSURE PLATE AND ROTOR

- (a) Inspect the pressure plate and rotor surfaces for wear and scoring. Replace if necessary.
- (b) Check the rotor bearings for wear and leakage of grease. Replace if necessary.

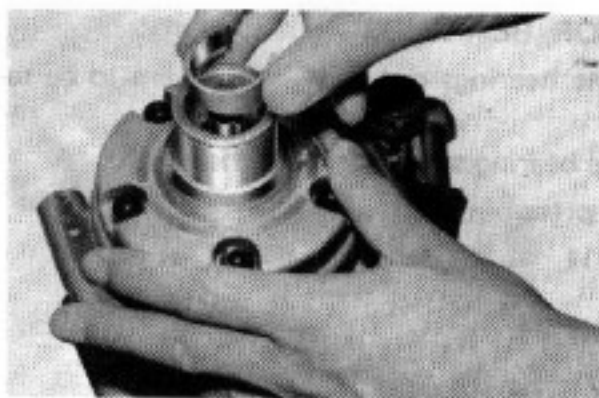
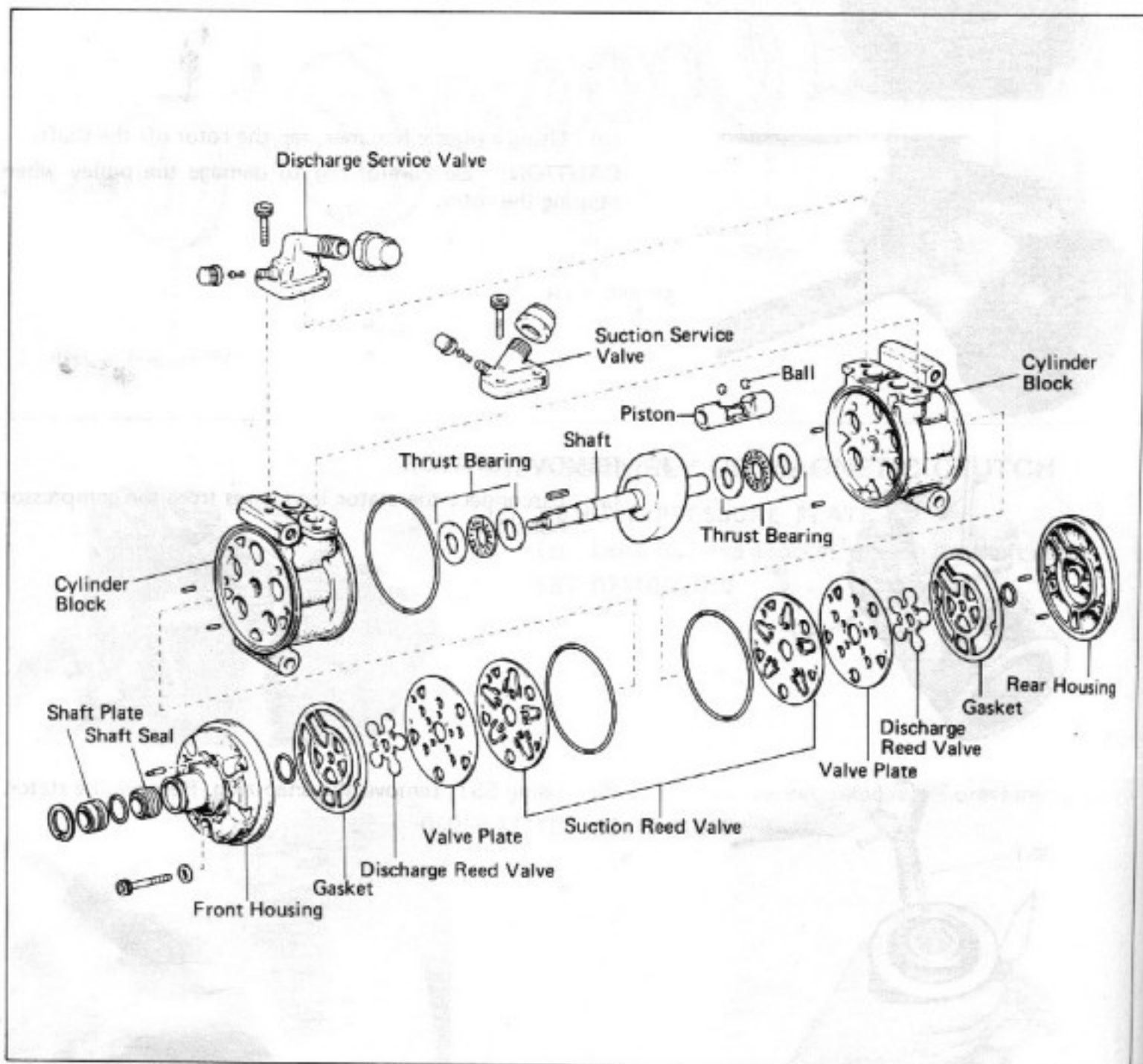
**DISASSEMBLY OF COMPRESSOR**

1. REMOVE FELT

**2. REMOVE CIRCLIP**

Using SST, remove the circlip.

SST 07114-84020

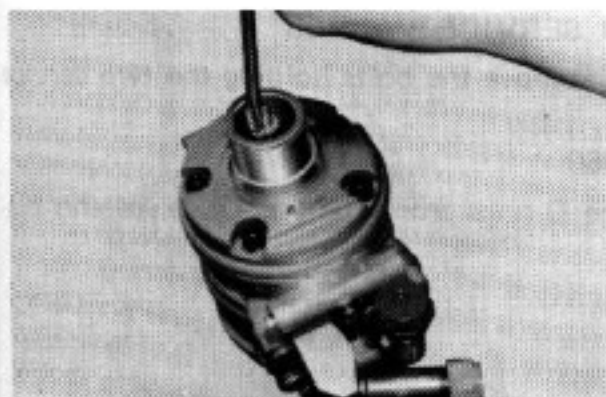
**3. REMOVE KEY**

Using a hammer and punch, drive the key from the shaft.

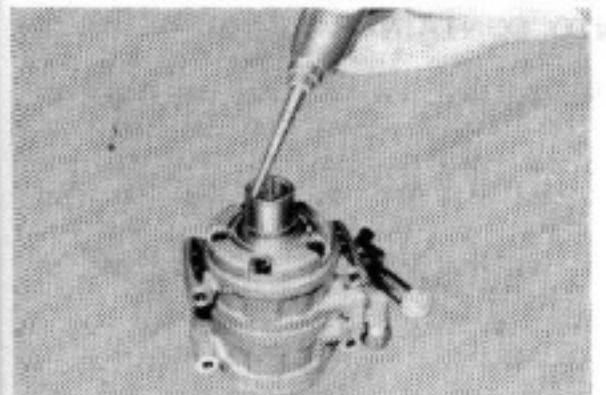
**4. APPLY COMPRESSOR OIL TO INNER BORE**

Apply compressor oil to the inner bore of the compressor.

**5. REMOVE SHAFT PLATE**

(a) Insert SST against the shaft. Then push the holder ring downward.

SST 07112-15010



(b) Pull up the bar of the remover, and remove the shaft plate.

6. REMOVE SHAFT SEAL

Insert SST against the shaft, and turn it clockwise while pressing in the remover.

Then remove the shaft seal.

SST 07114-15010

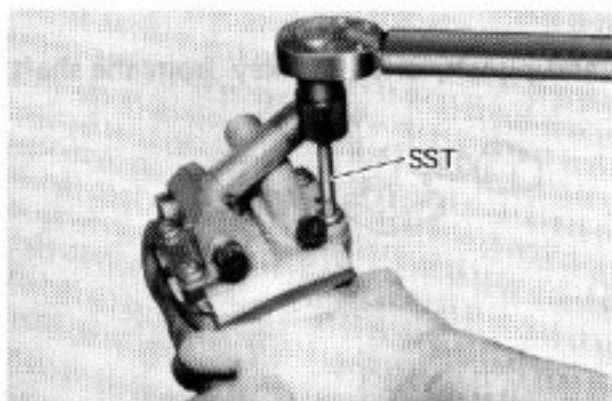
**7. REMOVE TWO SERVICE VALVES**

(a) Using SST, remove the bolts holding the two service valves.

SST 07110-61050

(b) Remove the O-rings from the service valves and discard them.

**8. DRAIN OIL INTO CONTAINER****9. REMOVE FRONT HOUSING**

(a) Using SST, remove the six through bolts.

NOTE: Do not reuse the six washers.

SST 07110-61050

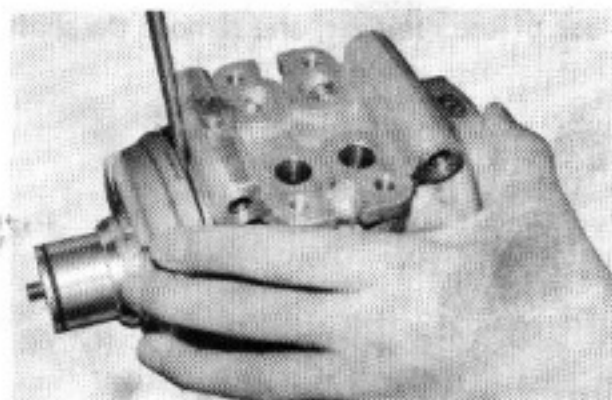

(b) Using a hammer and punch, remove the front housing by tapping on the protrusion.

CAUTION: Be careful not to scratch the sealing surface of the front housing.

10. REMOVE FRONT VALVE PLATE

- (a) Remove the two pins from the front housing. Discard the pins.

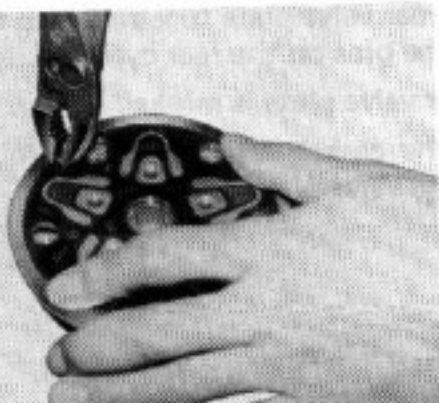
**11. REMOVE REAR HOUSING**

Using a hammer and punch, remove the rear housing by tapping on the protrusion.

CAUTION: Be careful not to scratch the sealing surface of the rear housing.

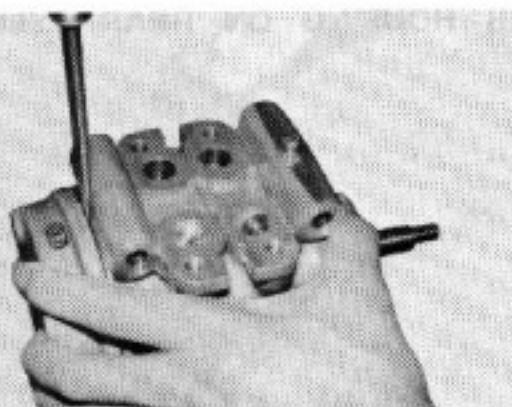
**12. REMOVE FRONT AND REAR O-RINGS FROM CYLINDER BLOCK**

Discard the O-rings.

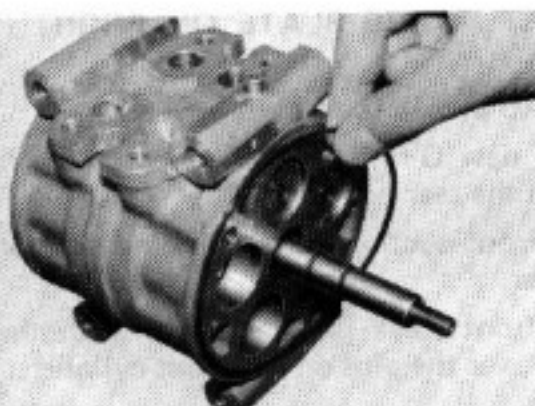
**ASSEMBLY OF COMPRESSOR**

(See page AC-26)

1. INSTALL REAR VALVE PLATE ON REAR CYLINDER

- (a) Install the two pins in the rear cylinder.
 (b) Lubricate a new O-ring with compressor oil. Install the O-ring in the rear cylinder.

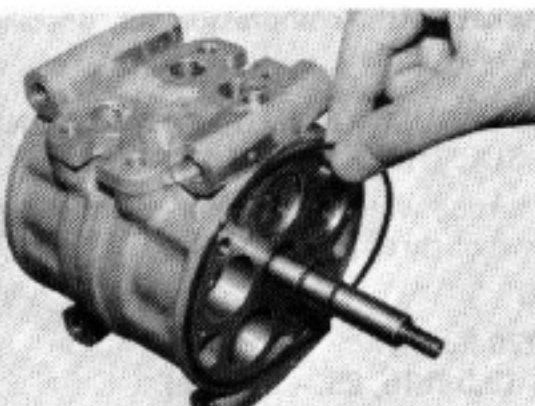

- (c) Install the rear suction valve over the pins on the rear cylinder.

NOTE: The front and rear suction valves are the same.





- (d) Install the rear valve plate together with the discharge valve over the pins on the rear cylinder.

NOTE: The rear valve plate is marked "R".

- (e) Lubricate the gasket with compressor oil. Install the gasket on the valve plate.

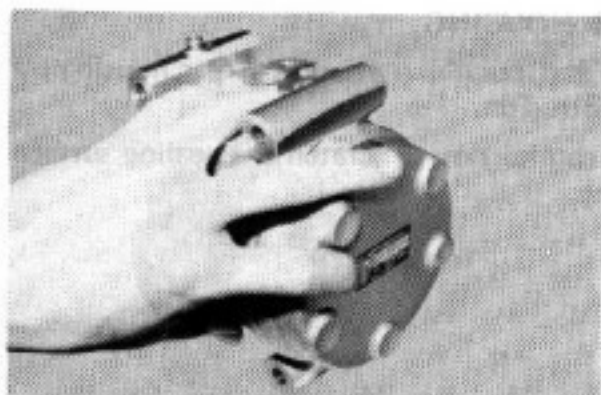

2. INSTALL REAR HOUSING ON REAR CYLINDER



3. INSTALL FRONT VALVE PLATE ON FRONT CYLINDER

- (a) Install the two pins in the front cylinder.
- (b) Lubricate a new O-ring with compressor oil. Install the O-ring in the rear housing.
- (c) Install the front suction valve over the pins on the front cylinder.
- (d) Install the front valve plate together with the discharge valve over the pins on the front cylinder.

NOTE: The front valve plate is marked with an "F".

- (e) Lubricate gasket with compressor oil. Install the gasket on the valve plate.

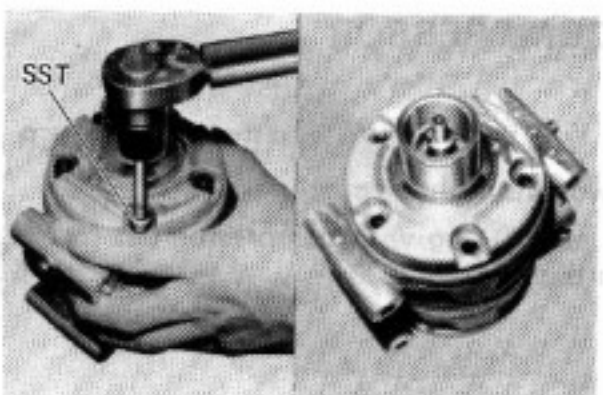

4. INSTALL FRONT HOUSING ON FRONT CYLINDER AND TIGHTEN SIX THROUGH BOLTS

Using SST and a torque wrench, gradually tighten the six through bolts in two or three passes.

SST 07110-61050

Torque: 250 – 270 kg-cm
(18.1 – 19.5 ft-lb, 25 – 26 N-m)

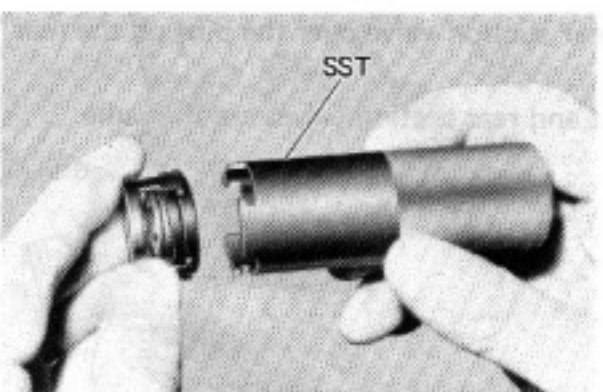

5. INSTALL SHAFT SEAL

- (a) Fit the shaft seal to SST.

SST 07114-15010

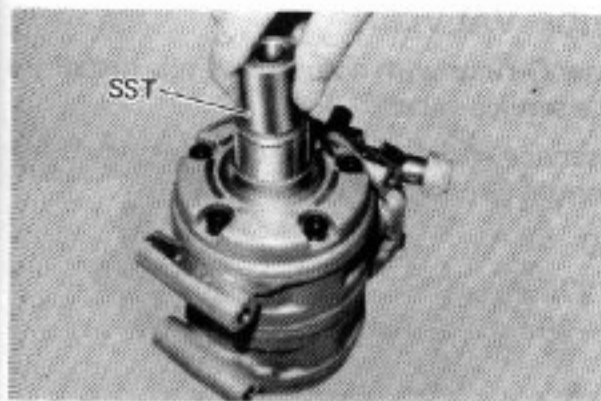

(b) Apply oil to the bore.

Insert SST, and turn it to the left while lightly pressing in. Then pull up SST.

SST 07114-15010

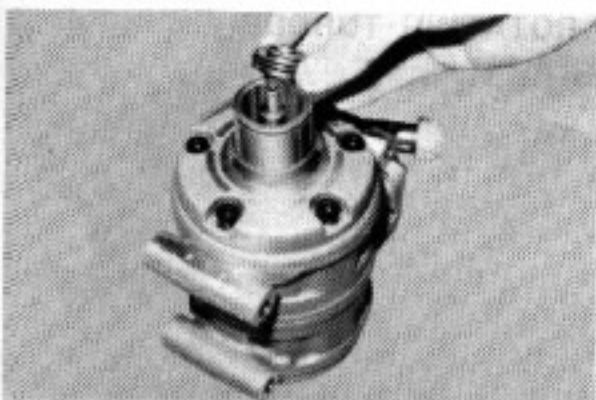

6. INSTALL SHAFT PLATE

(a) Put on the shaft plate.

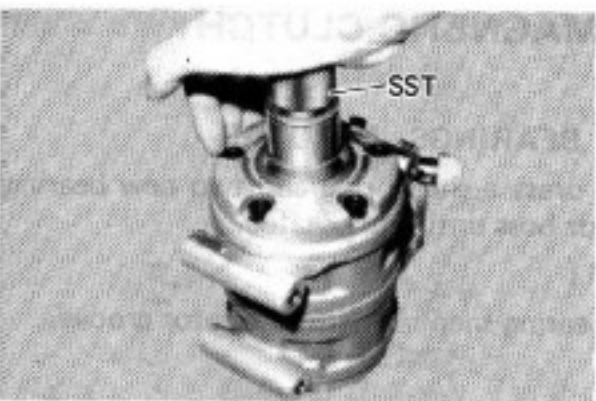

(b) Press in SST.

SST 07112-25010

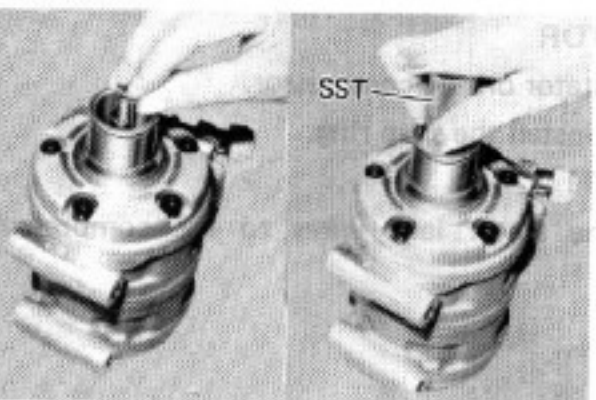

7. INSTALL KEY IN SHAFT GROOVE

Using SST and a plastic hammer, tap the key lightly.

SST 07114-45010

Put the felt inside the bore.

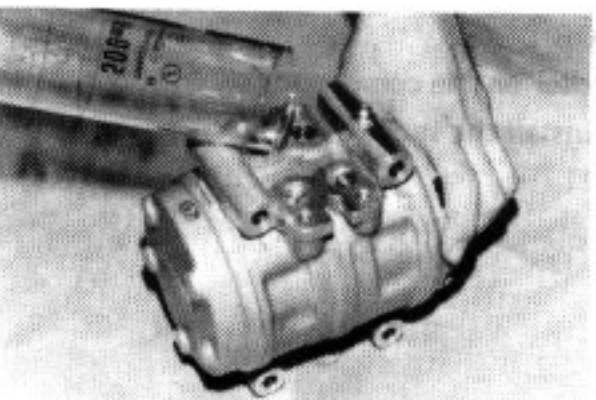

8. POUR COMPRESSOR OIL INTO COMPRESSOR

Compressor oil: **DENSOIL 6, SUNISO No.5GS, or equivalent**

Refill capacity:

Per <http://www.delanet.com/~pparish/oil-tabl.htm>,

total system capacity is 8.0 oz

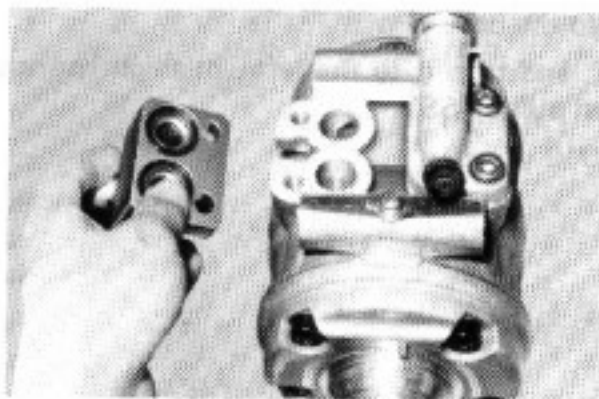

9. INSTALL SERVICE VALVES

- (a) Lubricate new O-rings with compressor oil. Install the O-rings in the service valves.
- (b) Install the service valves on the compressor. Using SST and a torque wrench, tighten the bolts.

SST 07110-61050

Torque: 250 – 270 kg-cm
(18.1 – 19.5 ft.-lb, 25 – 26 N-m)



10. CHECK SHAFT ROTATING TORQUE

Torque: 30 kg-cm (26 in.-lb, 2.9 N-m) or less

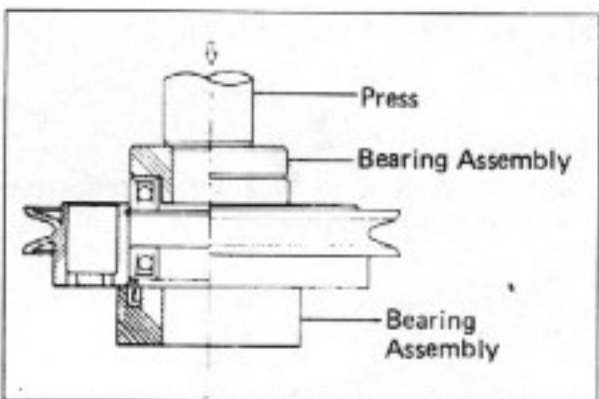

ASSEMBLY OF MAGNETIC CLUTCH

(See page AC-24)

1. INSTALL TWO BEARINGS IN ROTOR

- (a) Using SST, press a shield ring and two new bearings into the rotor boss until fully seated.

SST 07110-77011

- (b) Install the bearing snap ring into the rotor groove.

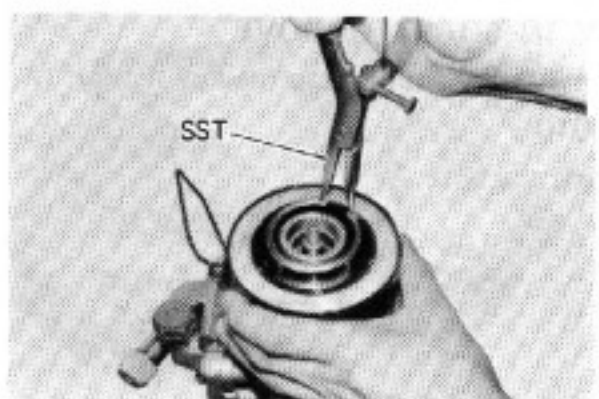

2. INSTALL STATOR

- (a) Install the stator on the compressor.
- (b) Using SST, install the snap ring.

SST 07110-77011

- (c) Connect the stator lead wires to the compressor housing.

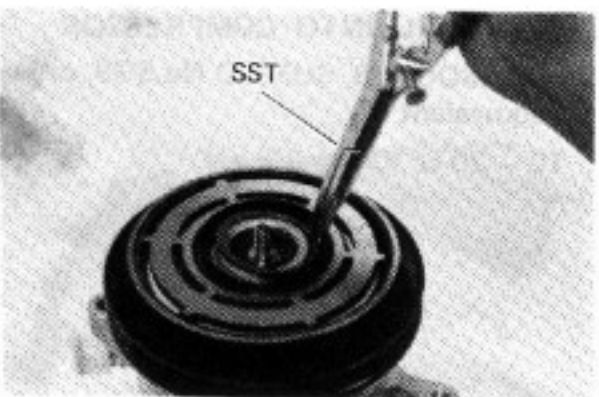

3. INSTALL ROTOR

- (a) Install the rotor on the compressor shaft.
- (b) Using SST, install the snap ring.

SST 07110-77011

4. INSTALL PRESSURE PLATE

- (a) Adjust the clearance between the pressure plate and rotor by placing shims on the compressor shaft.
Standard clearance: 0.4 – 0.7 mm (0.016 – 0.028 in.)

If the clearance is not within tolerance, add or reduce the number of shims to obtain the standard clearance.

- (b) Using SST and a torque wrench, install the shaft nut.
SST 07110-77011

Torque: 150 – 175 kg-cm (11 – 12 ft-lb, 15 – 17 N-m)

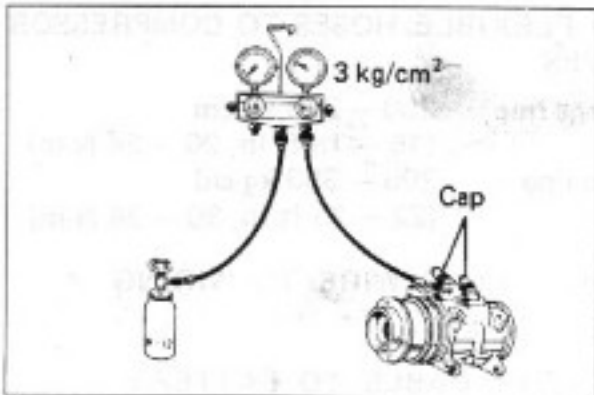
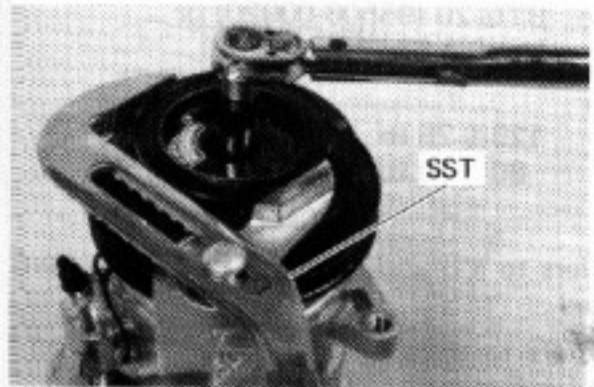

PERFORMANCE TEST OF COMPRESSOR

1. PERFORM GAS LEAKAGE TEST

- (a) Put caps on both service valves.
 (b) Charge the compressor with refrigerant through the charging valve until the pressure is 3 kg/cm² (43 psi, 294 kPa).
 (c) Using gas leak detector, check the compressor for leaks.

If leaks are found, check and replace the gasket, O-ring, or shaft seal.

2. IF NECESSARY FILL COMPRESSOR WITH CLEAN COMPRESSOR OIL

Remove the service valve and drain the compressor oil. Fill with new oil.

Compressor oil: DENSOIL 6, SUNISO No. 5GS or equivalent.

Refill capacity:

US Sterling manual says to drain compressor & refill w/ same amount

3. EVACUATE COMPRESSOR AND CHARGE WITH REFRIGERANT (See page AC-11)

Make sure the caps are tight and free from moisture and contamination.

NOTE: When storing a compressor for an extended period, charge it with refrigerant or dry nitrogen gas to prevent corrosion.