

Instruction Manual



ROiK-MIB2

ANDROID INTERFACE

Android 8.1.0 (Oreo)

DATE.

2020.03.11



COMPONENTS

[ANDROID INTERFACE]

ROiK-MIB2

		
<p>ROiK-MIB2</p>	<p>Power/CAN Cable</p>	<p>Universal Cable</p>
		
<p>LVDS Cable</p>	<p>AV Cable</p>	<p>IR Cable</p>
		
<p>Speaker</p>	<p>External GLONASS GPS Antenna</p>	<p>WiFi/BT Antenna x 2</p>
		
<p>MIC</p>	<p>Key Pad</p>	

SPEC

※ ANDROID

OS	Android 8.1.0(Oreo)
CPU	Six-Core 64bit Server Class Cortex-A72 Core @2.0Ghz, Mali-T860 Quad-Core GPU (Total Ten-Core)
VPN	H.264/H.265/VP9 up to 4Kx2K@60fps (4K Video)
Memory	2GB DDR3
USB	USB2.0 High Speed Port x 1
USB 3.0	USB3.0 5.0Gbps Port x 1
Wireless	2.4GHz/5GHz Dual-Band WiFi, Support 802.11a/b/g/n/ac, Bluetooth 4.1
GPS	Ublox8 GPS(GLONASS/BEIDOU/GALILEO/QZSS/SBAS)
HDMI OUT	HDMI 2.0, Support maximum 4K@60Hz display
Speaker	2W
I/O	Mic (voice recognition),
Temperature	-20°C ~ 80°C
Operating	-15°C ~ 70°C

※ INTERFACE

Input Spec.	1 x HDMI IN (1280x720), 2 x A/V Input (external video source) 1 x CVBS (Front Camera) 1 x CVBS (Rear Camera)
Output Spec.	1 x Audio L/R Output 1 x LVDS Output (LCD Operation)
Power Spec.	Input Power : 12V DC ~ 24V DC Consumption Power : 12 Watt Max
I/O	Input : 10P Dip Switch Output : 12V Output (3A Max) DVB-T IR (Remote Control) DVD IR (Remote Control)

CONNECTOR PIN ASSIGNMENT

Power Cable (POWER/CAN)



1	3	5	7	9	11	13	15
Yellow		Purple	Green		White	Purple	Orange
BATTERY	N.C	VDD-12V	REVERSE	N.C	ECU_CAN_IN_H	MON_CAN_IN_H	MON_CAN_OUT_H
2	4	6	8	10	12	14	16
Black			Orange		Blue	Brown	Green
GND	N.C	N.C	REAR_12V	N.C	ECU_CAN_IN_L	MON_CAN_IN_L	MON_CAN_OUT_L



AV Cable (AV IN)

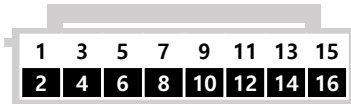

1	3	5	7	9	11	13	15
White	White	White	White	White	White	White	White
AV1_IN_V	AV1_IN_R	AV1_IN_L	AV2_IN_V	AV2_IN_R	AV2_IN_L	FRONT_IN	REAR_IN
2	4	6	8	10	12	14	16
Black	Black	Black	Black	Black	Black	Black	Black
GND	GND	GND	GND	GND	GND	GND	GND

Universal Cable (AV IN/OUT)

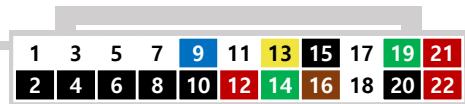

1	3	5	7	9	11	13	15	17	19	21
White	White	White	White	Blue	White	Yellow	Red	White	Brown	Green
SPK_P	AUX_OUT_R	AUX_OUT_L	MIC_P	Capacitive Touch SCL	Capacitive Touch SDA	Capacitive Touch Interrupt	UART TX	UART RX	DVB-T IR	DVD IR
2	4	6	8	10	12	14	16	18	20	22
Black	Black	Black	Black	Black	Red	Green	Black	White	Black	Red
SPN_N	GND	GND	MIC_N	GND	Capacitive Touch 3.3V	Capacitive Touch Reset	UART_GND	IR_IN	IR_GND	IR_POWER

DIP S/W INFORMATION

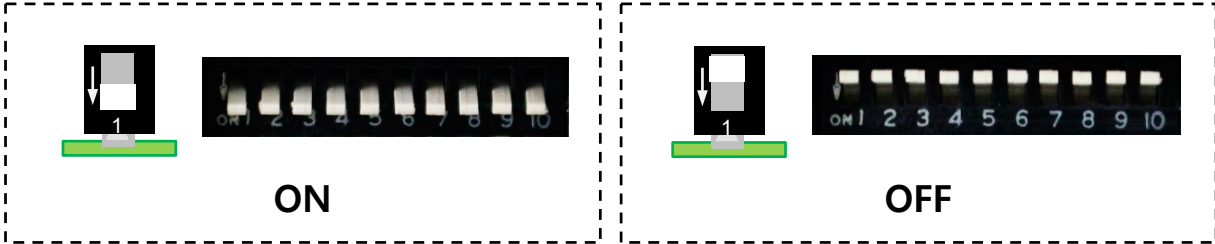

Pin No.	ON	OFF
1	HDMI Mode	Skip HDMI Mode
2	External Rear Camera	Original Rear Camera
3	External Front Camera	Skip External Front Camera
4	DVB-T Mode	Skip DTV Mode
5	DVD Mode	Skip DVD Mode
6	NC	NC
7	Selection of Car Model (Next Page)	
8		
9		
10		

DIP S/W INFORMATION

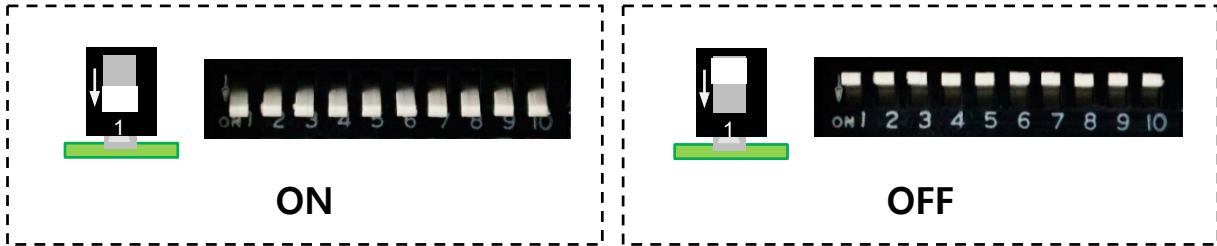

※ Selection of Car Model

7	8	9	10	Brand	Model	Inch	Remark
On	Off	On	Off	Audi	A3	5.8"	MMI Radio (Low Resolution)
On	Off	Off	On	Audi	A3	7"	MMI Radio
Off	On	On	On	Audi	A4, Q5	7"	MIB2
Off	Off	On	Off	Audi	Q7, Q5	8.3"	MIB2
Off	Off	Off	On	Bentley	Bentayga	8"	MIB2
Off	On	Off	On	Porsche	PCM 4.0 / PCM 4.1	8"	PCM 4.0 PCM 4.1
Off	Off	On	On		Panamera	12.3"	PCM 4.1

※ Porsche car Bluetooth by "BT-AUX", not work with ROIK-MIB2 Bluetooth

Off	On	On	Off	Volkswagen	Golf, Passat, Tiguan	5.8"	Automatic Transmission Composition Media Composition Colour
				Skoda	Octavia		
Off	Off	Off	Off	Volkswagen	Golf, Passat, Tiguan	6.5", 8"	Automatic Transmission 2017 Discover Media Discover Media, Pro Composition Media
				Skoda	Octavia		
Off	On	Off	Off	Volkswagen	Golf, Passat, Tiguan	9.2"	Automatic Transmission 2017 Discover Pro
On	On	On	Off	Volkswagen	Golf, Passat, Tiguan	5.8"	Manual Transmission Composition Media Composition Colour
				Skoda	Octavia		
On	Off	Off	Off	Volkswagen	Golf, Passat, Tiguan	6.5", 8"	Manual Transmission 2017 Discover Media Discover Media, Pro Composition Media
				Skoda	Octavia		

DIP S/W INFORMATION

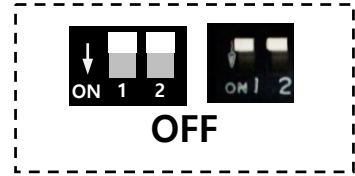
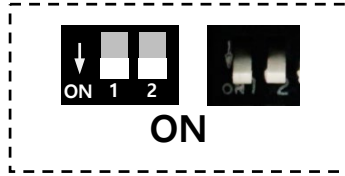

Pin No.	On	Off
1	1200x720 (Same Ratio 800x480)	1280x720
2	Use External GPS Antenna (DIP S/W 2 Must ON)	Use Car GPS Cable (Option)



SCREEN VIEW

[ANDROID INTERFACE]

ROIK-MIB2

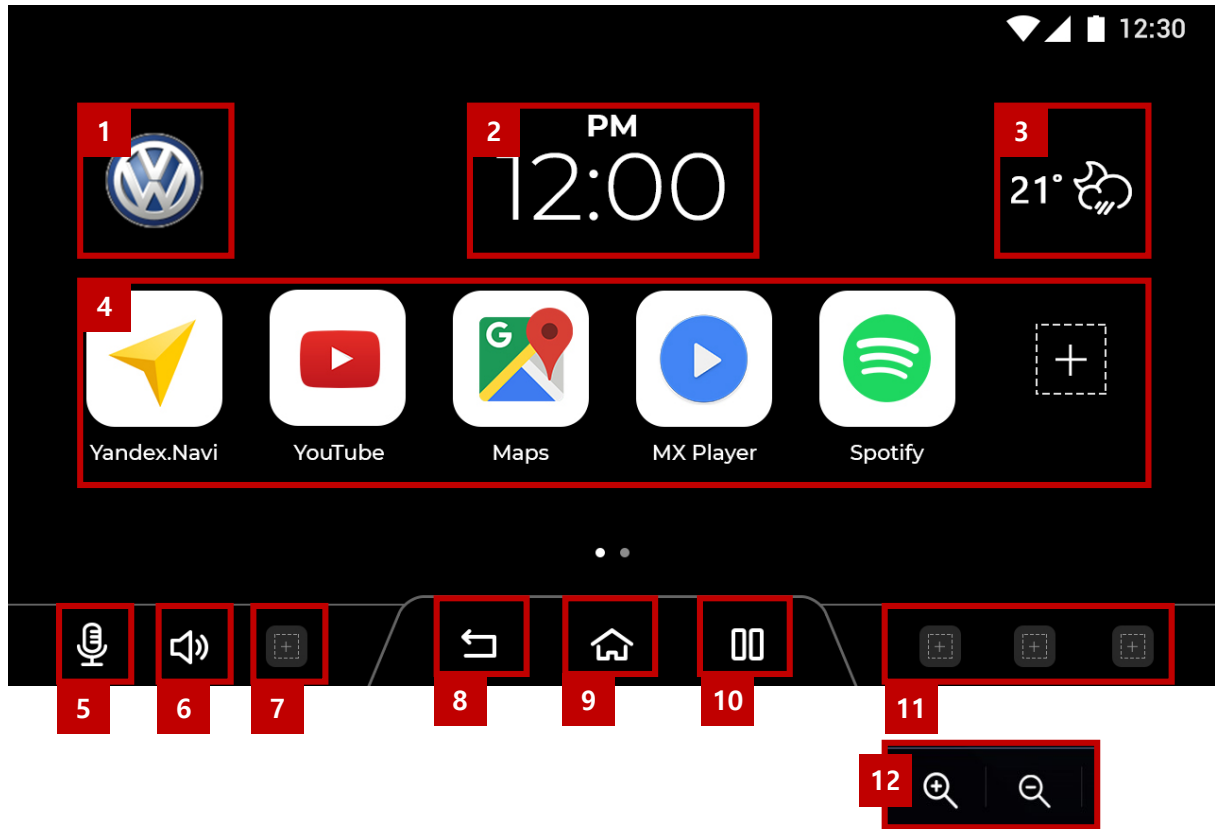

1	Car Logo	7	APP Shortcut
2	Clock	8	Back Button
3	Weather widget	9	Home Button
4	APP Shortcut	10	Multitasking
5	Voice	11	APP Shortcut
6	Sound	12	Zoom Tool

SCREEN VIEW – Split Screen Mode

[ANDROID INTERFACE] ROIK-MIB2

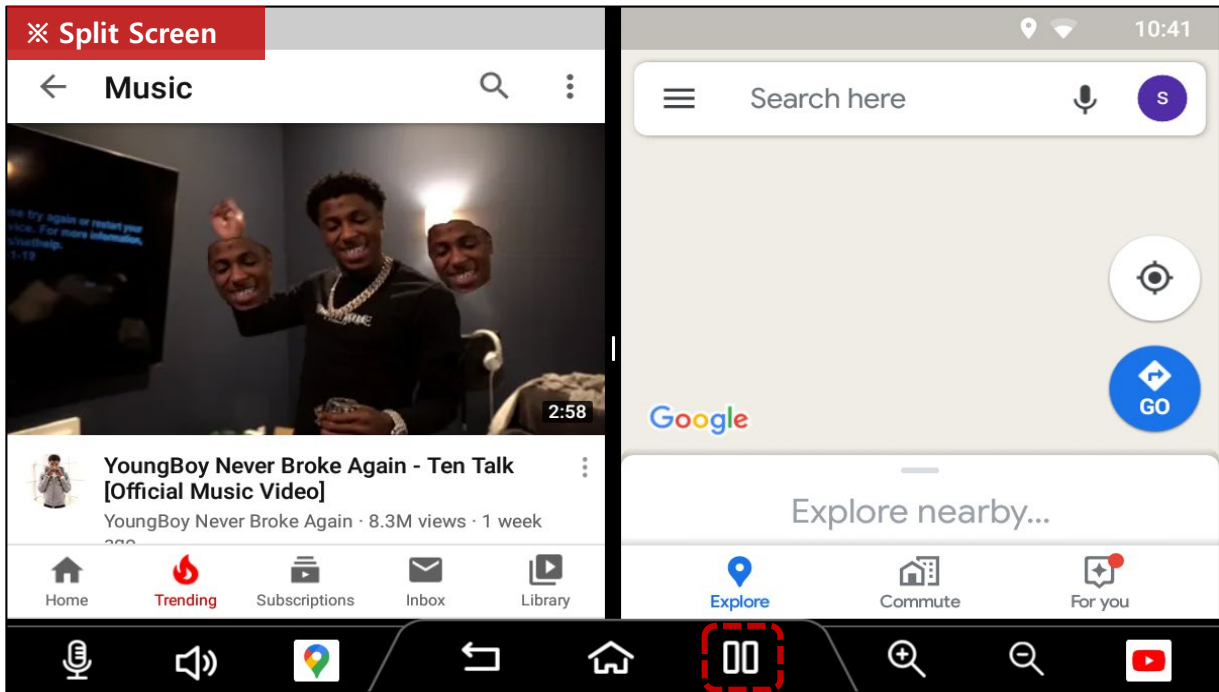

- 1 Press and hold the multi-tasking button to enter the split screen mode.
- 2 In the split screen mode, press center to reverse the direction.

※ Some apps are not work on Split Screen Mode

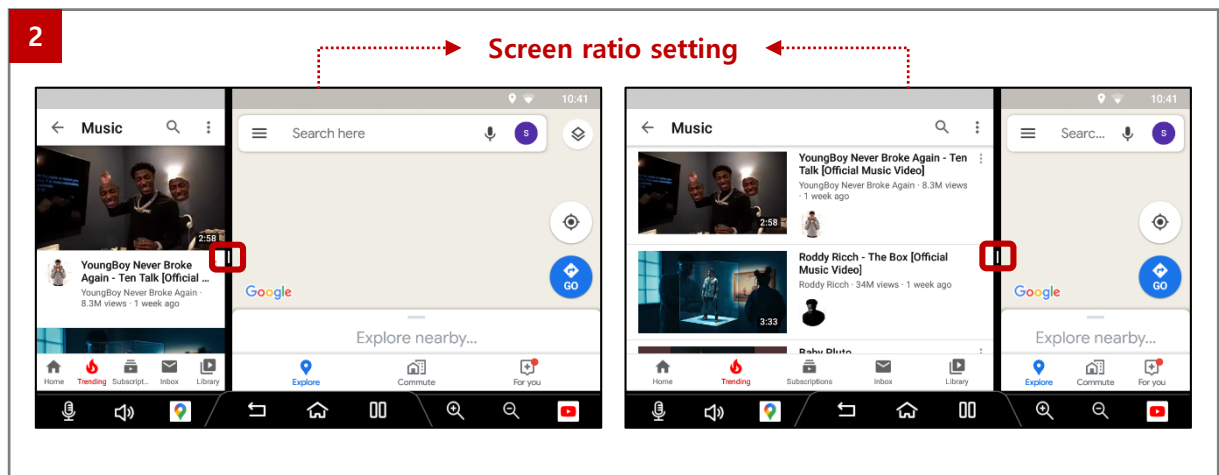
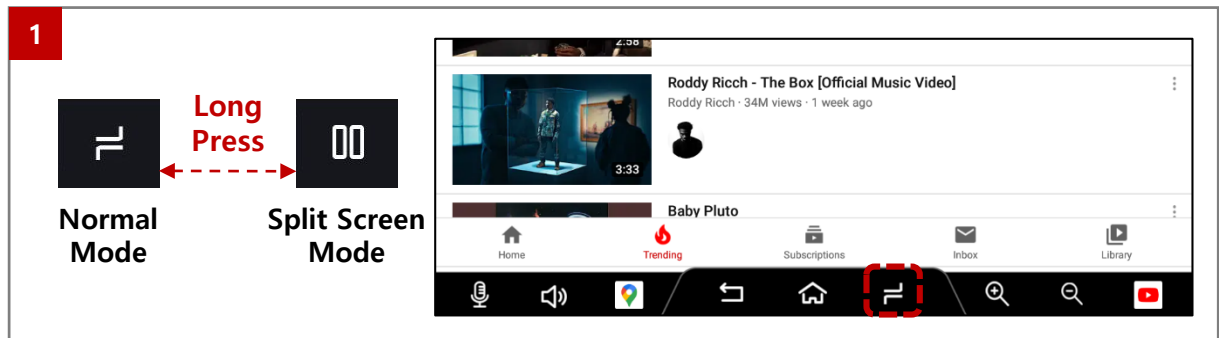

CABLE CONNECTION

[ANDROID INTERFACE]

ROiK-MIB2

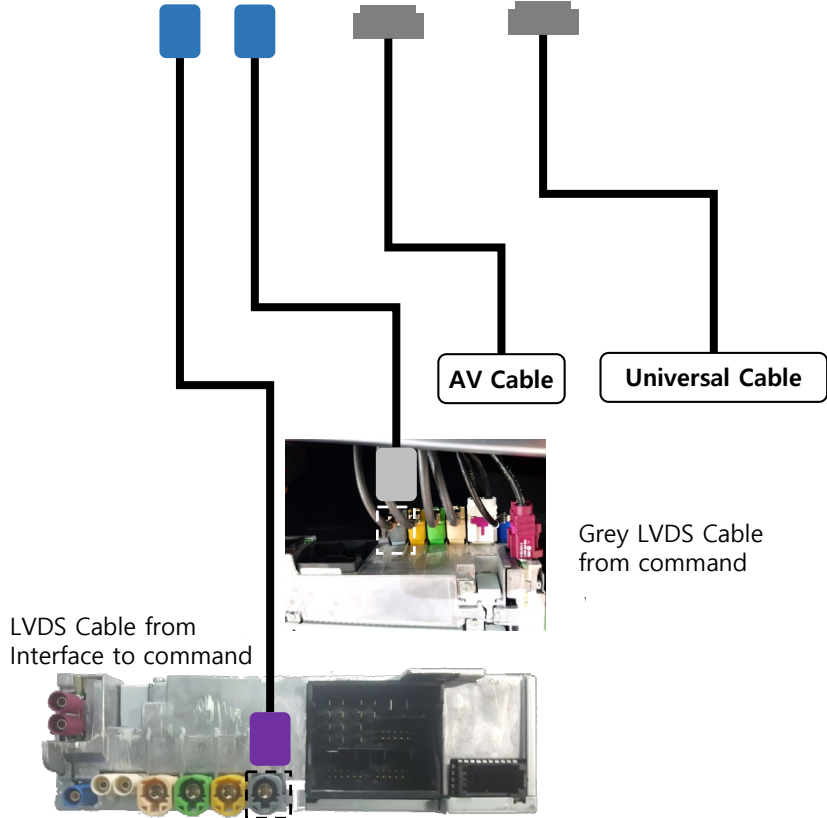
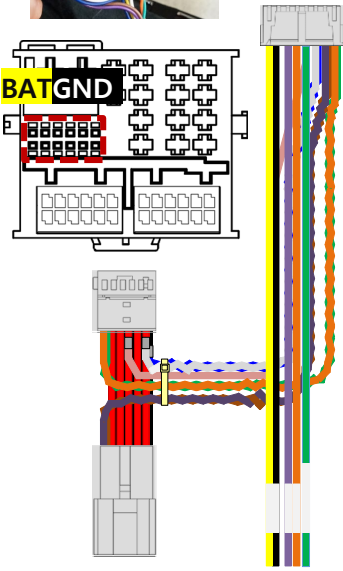
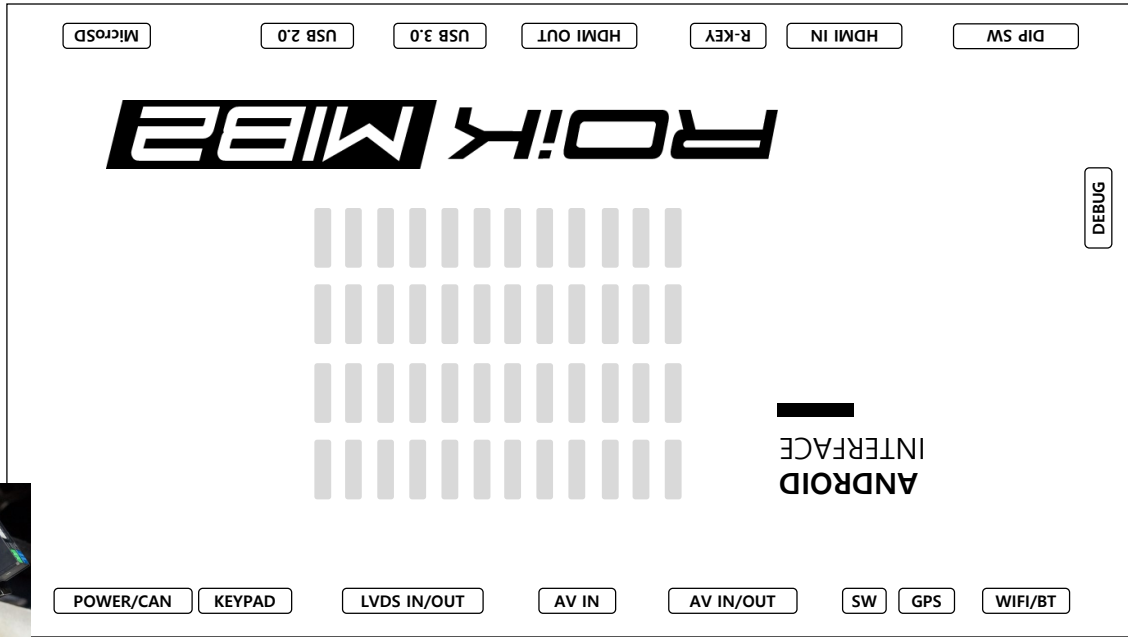

OEM BUTTON USAGE - AUDI

[ANDROID INTERFACE]

ROIK-MIB2



No.	Button	Press	Function
Steering wheel			
1	BACK	Long Press (2sec)	Front View Camera
		Short Press	Change to previous screen
2	NAV	Short Press	Back to oem screen
Touch pad			
3	NAV/MAP	Short Press	Back to oem screen
4	TEL		
5	RADIO		
6	MEDIA		
7	Move Wheel	Dial, Push	Remote menu choice and move (DVBT,DVD)

OEM BUTTON USAGE - BENTLEY

[ANDROID INTERFACE]

ROIK-MIB2



No.	Button	Press	Function
1	NAV	Press for 2sec	Change to interface home screen
		Short Press	Change to previous screen
	RADIO	Short Press	Back to OEM screen
	MEDIA		
	TEL		
	HOME		
	BACK		

OEM BUTTON USAGE – PORSCHE (PANAMERA)

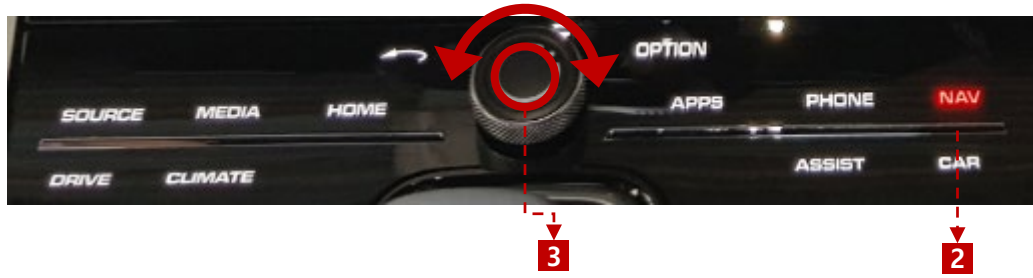

No.	Button	Press	Function
Radio Button			
2	NAV	Long Press (2sec)	HDMI->NAVI->DVBT->DVD->OEM
		Short Press	Back to oem screen
3	Jog Wheel	Dial, Push	Remote menu choice and move (DVBT,DVD)

OEM BUTTON USAGE - PORSCHE (PCM 4.0)

[ANDROID INTERFACE]

ROIK-MIB2



No.	Button	Press	Function
1	NAV	Press for 2sec	Change to interface home screen
		Short Press	Change to previous screen
	Tuner	Short Press	Back to OEM screen
	Media		
	Map		
	Source		
	Phone		
	Car		
	Home		

OEM BUTTON USAGE - VOLKSWAGEN / SKODA

[ANDROID INTERFACE]

ROIK-MIB2



No.	Button	Press	Function
1	MENU	Long Press (2sec)	Change to previous screen
		Short Press	Back to OEM screen
	RADIO	Short Press	Back to OEM screen
	MEDIA		
	PHONE		
	CAR		
	SETUP		
	SOUND		
	MUTE	Short Press	OEM function



No.	Button	Press	Function
Monitor Button			
1	MENU	Long Press (2sec)	HDMI->NAVI->DVBT->DVD->OEM
		Short Press	Back to oem screen

OEM BUTTON USAGE - Skoda

[ANDROID INTERFACE]

ROIK-MIB2



No.	Button	Press	Function
1	MENU	Long Press (2sec)	Change to previous screen
		Short Press	Back to OEM screen
	RADIO	Short Press	Back to OEM screen
	MEDIA		
	PHONE		
	CAR		
	SETUP		
	SOUND		
	MUTE	Short Press	OEM function

REMOTE CONTROL (How To Control) - DVBT / DVD

[ANDROID INTERFACE]

ROIK-MIB2



You can select a menu by turning the jog dial. (for DTV, DVD)

 AUDI(Q7, Q5)



PORSCHE(PANAMERA)



DVB-T CONNECTION DIAGRAM FOR AV INPUT

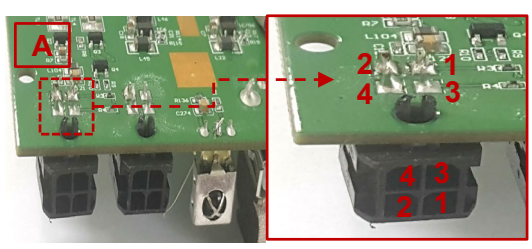

1	IR - DVB-T
2	DO NOT USE.
3	DO NOT USE.
4	DO NOT USE.

Open the cover of DVB-T.
Connect 'DVBT-IR' provided to 'A' on picture

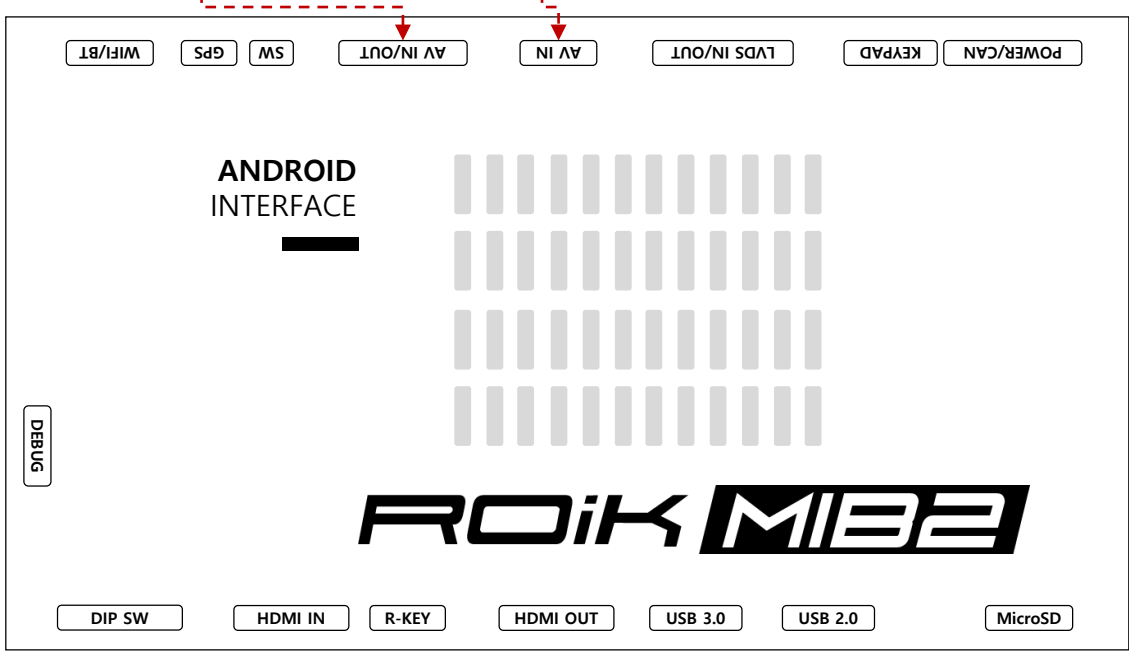
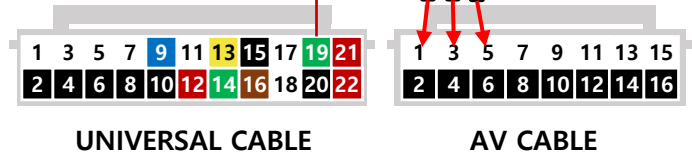
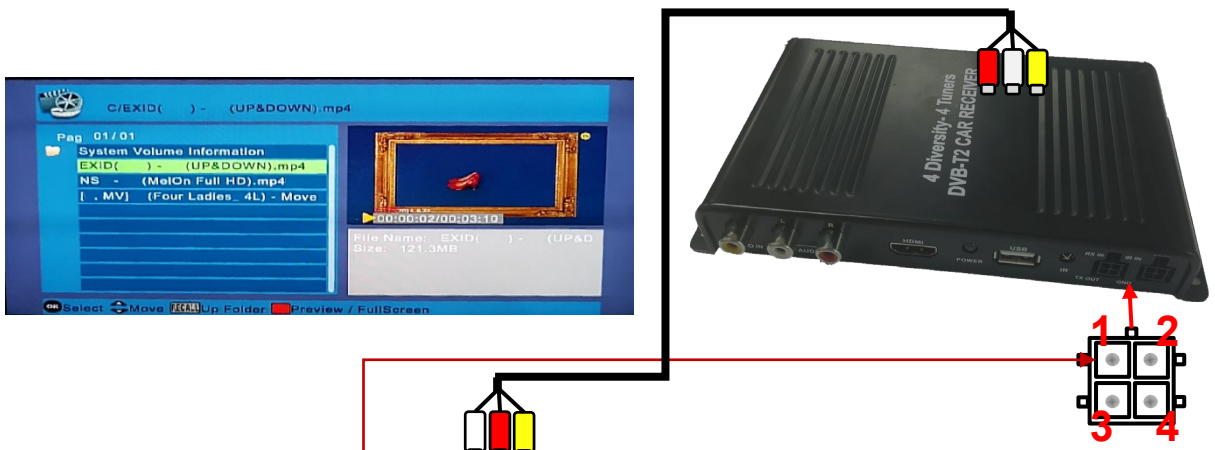

ADD REMOTE CONTROLLER

[ANDROID INTERFACE]

ROIK-MIB2

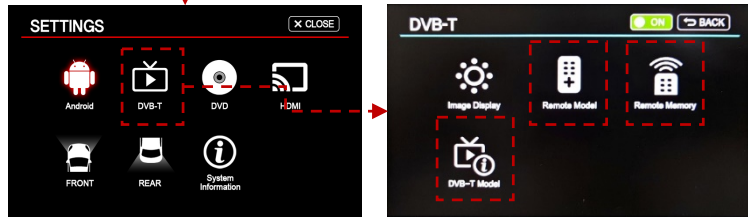
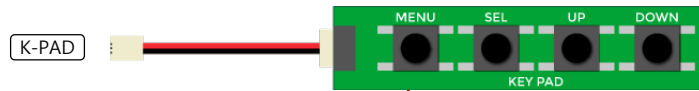

Enter the setting menu. And DVB-T select.

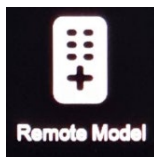

Remote Model
Setting Remote select

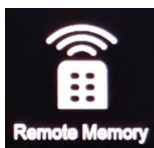
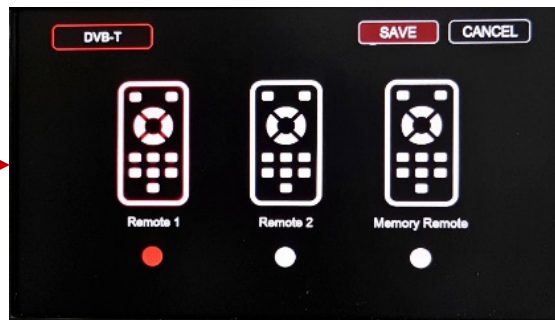

Remote Memory
Selected remote control setting

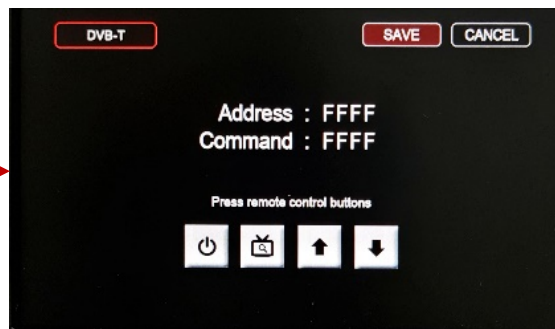

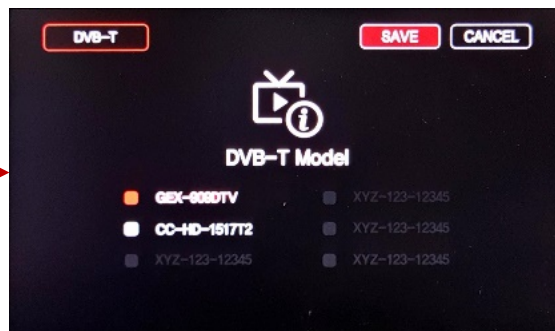

DVB-T Model
DVB-T Model select



MMI TOUCH PAD GESTURE - AUDI



- 
Click
 Push Touch pad
- 
Scroll
 Slide two fingers up or down the touch pad to scroll
- 
Drag
 Push Touch pad and sliding

YouTube



Apply YouTube gesture

By watching video on YouTube, press the MMI Touch pad and Slide MMI Touch Pad to Close Video.

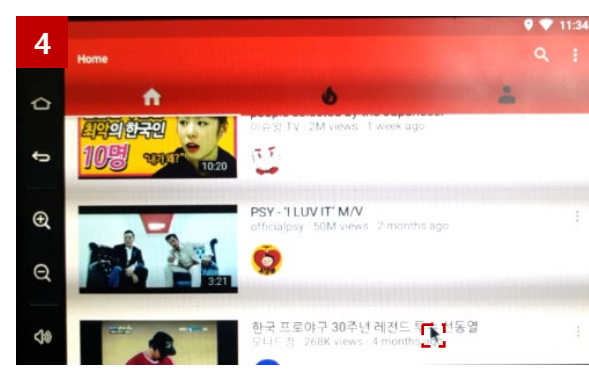
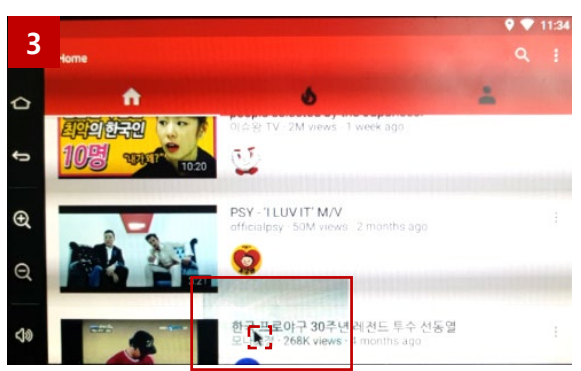
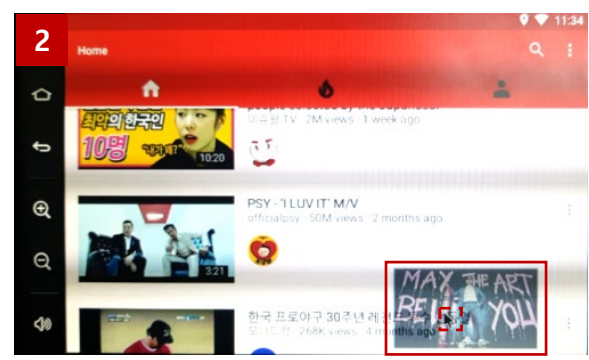
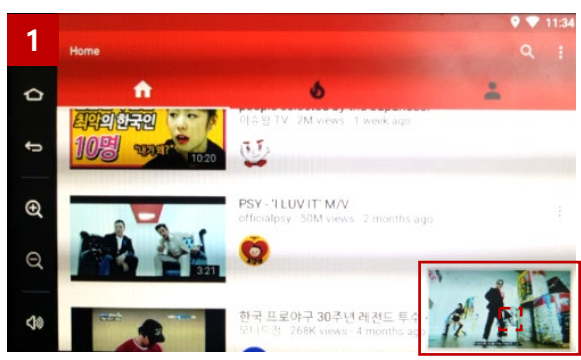

TOUCH SCREEN GESTURE PORSCHE (PANAMERA) / VOLKSWAGEN (TIGUAN)



Apply YouTube gesture

By watching video on YouTube, press the display and Slide then Close video

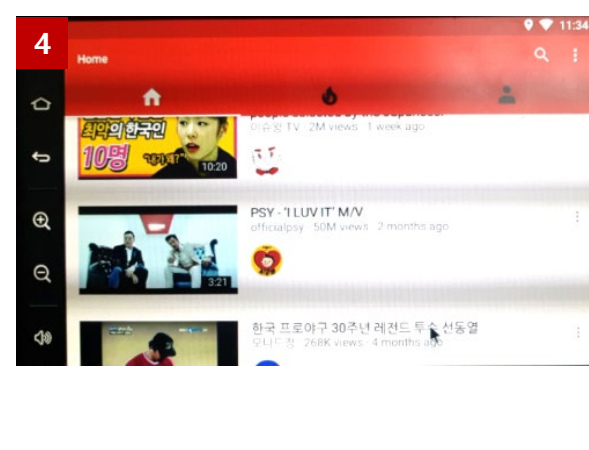
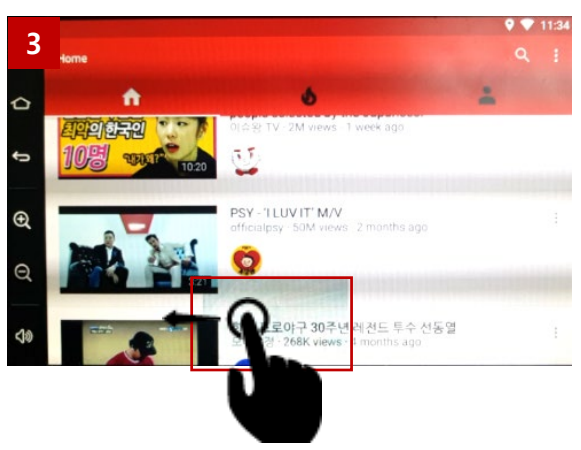
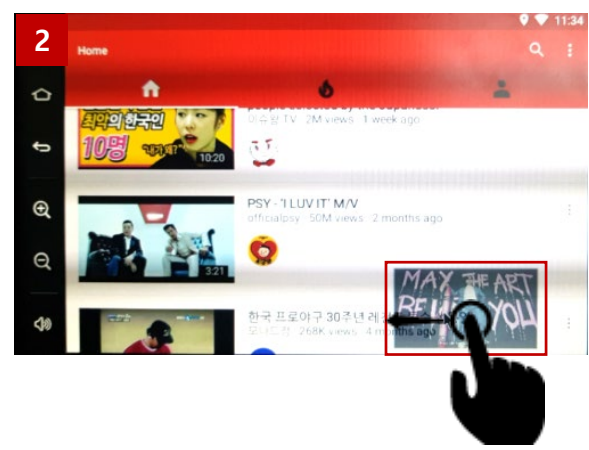
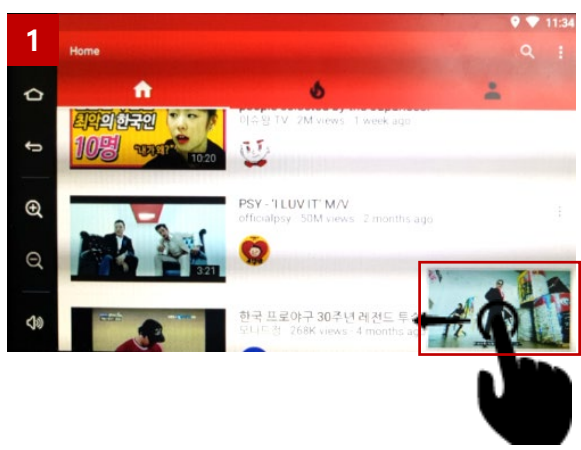

HEADREST MONITOR

※ Headrest Monitor (HDMI Out)



HDMI

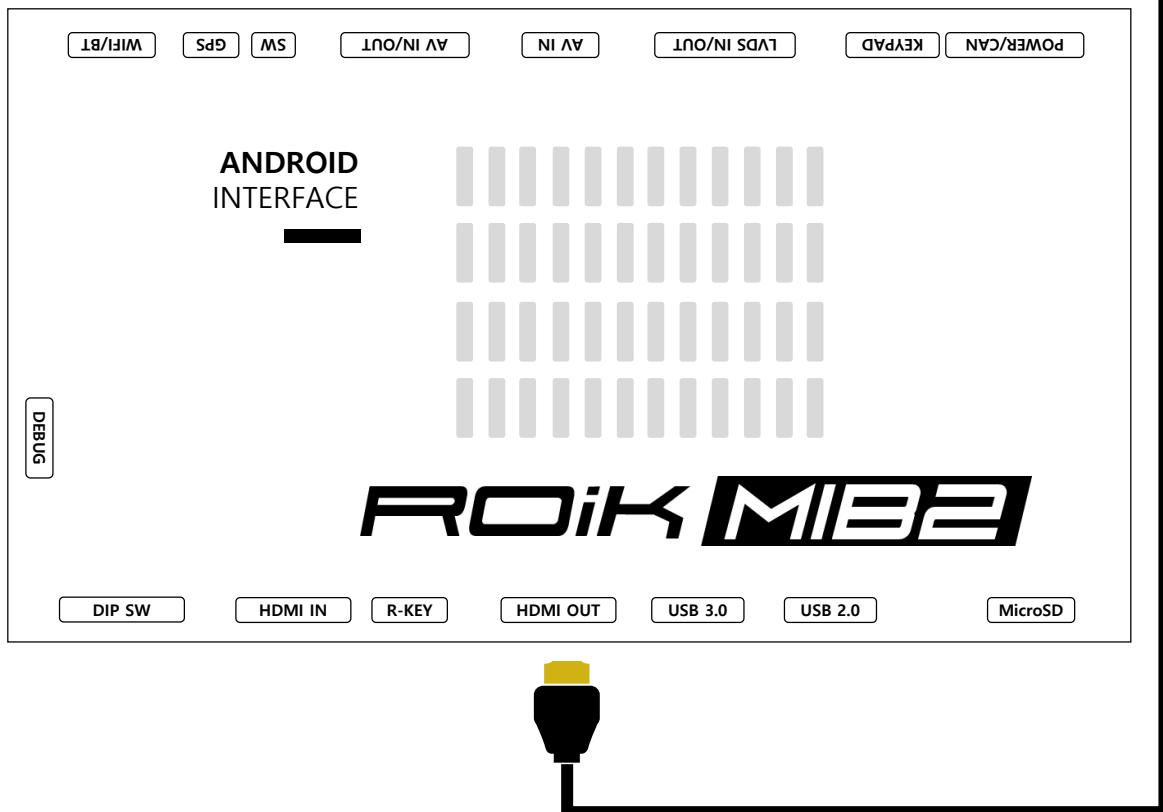

DEVICE SETTINGS

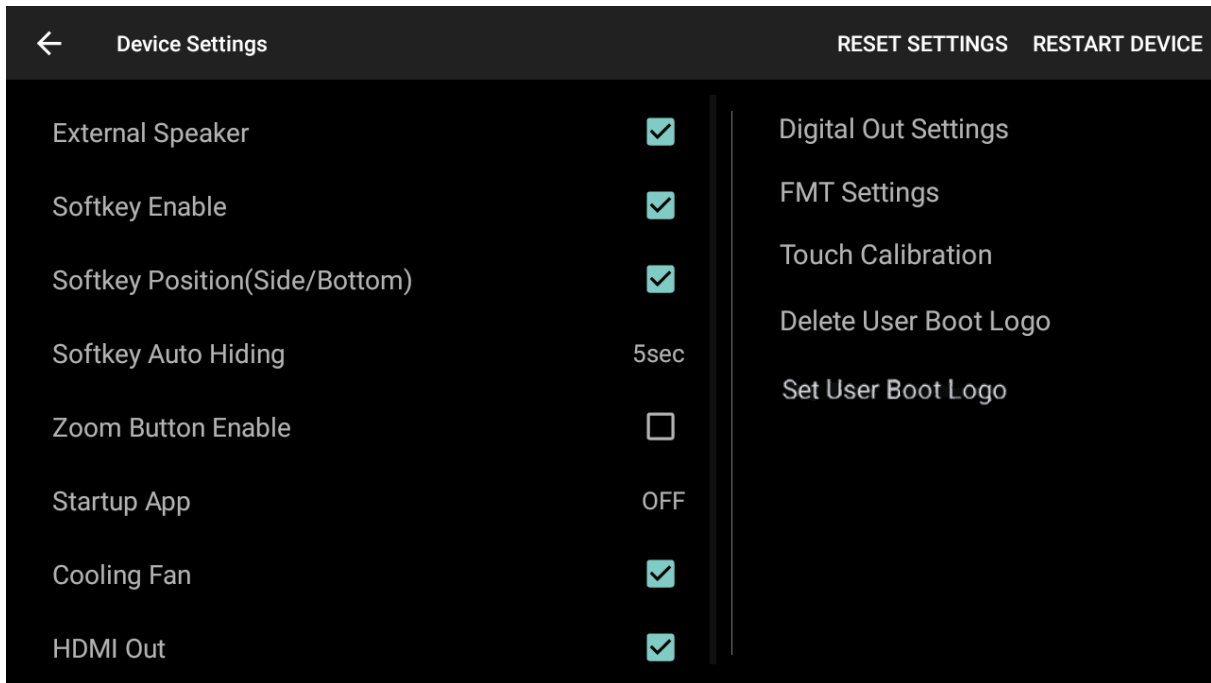

No.	Button	Function
1	RESET SETTINGS	Reset settings to default
2	RESTART DEVICE	System Reboot
3	External Speaker	Turn on/off external speaker
4	Softkey Enable	Use soft key or disable (Floating button when disabled)
5	Softkey Position	Soft key position setting (side, bottom)
6	Softkey Auto Hiding	Set softkey auto-hide time
7	Zoom Button Enable	Enable or Disable the Zoom Button on the Soft Key
8	Startup App	Select Startup APP
9	Cooling Fan	Turn on / off Cooling Fan
10	HDMI OUT	Turn on / off HDMI Out
11	Digital Out Settings	(Developer menu) DIGITAL LVDS only, Screen Settings - Position, Brightness, Contrast, Sharpness
12	FMT Settings	Select FM transmitter frequency
13	Touch Calibration	Touch Calibration (for UART Touch)
14	Set User Boot Logo	File Format : PNG, JPG, BMP Image Size : 1280 X 720 pixel
15	Upgrade Device	(Hidden menu) Firmware update is available.

DEVICE SETTINGS

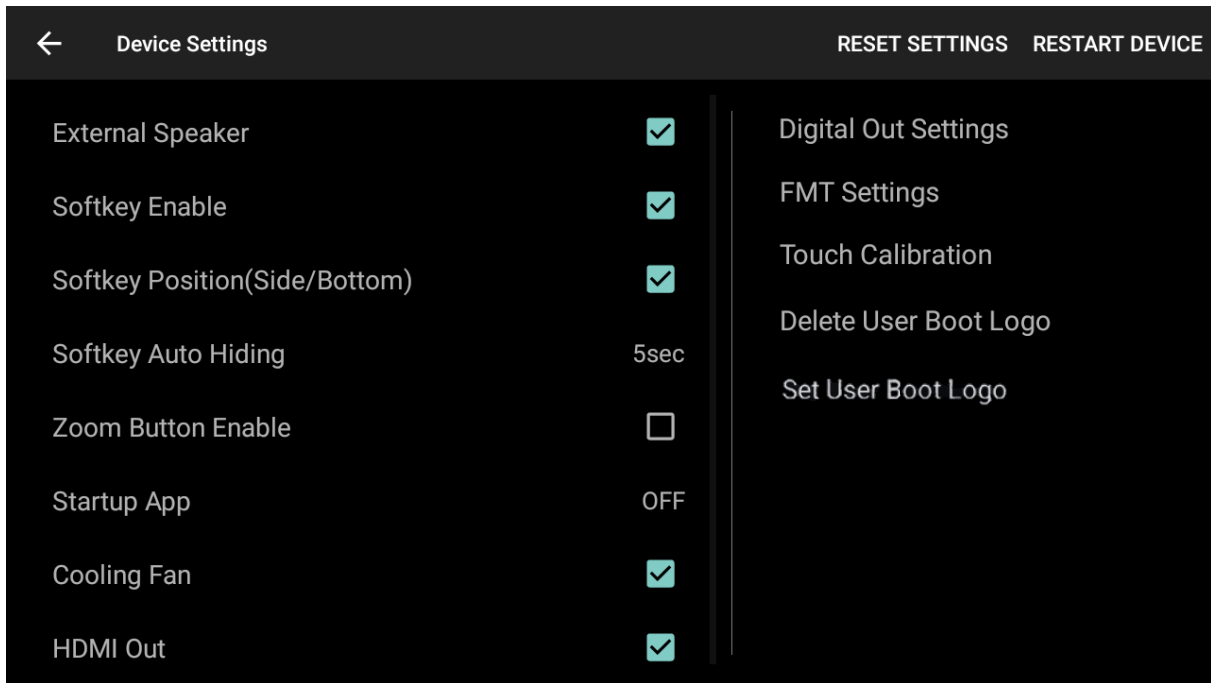

No.	Button	Function
1	RESET SETTINGS	Reset settings to default
2	RESTART DEVICE	System Reboot
3	External Speaker	Turn on/off external speaker
4	Softkey Enable	Use soft key or disable (Floating button when disabled)
5	Softkey Position	Soft key position setting (side, bottom)
6	Softkey Auto Hiding	Set softkey auto-hide time
7	Zoom Button Enable	Enable or Disable the Zoom Button on the Soft Key
8	Startup App	Select Startup APP
9	Cooling Fan	Turn on / off Cooling Fan
10	HDMI OUT	Turn on / off HDMI Out
11	Digital Out Settings	(Developer menu) DIGITAL LVDS only, Screen Settings - Position, Brightness, Contrast, Sharpness
12	FMT Settings	Select FM transmitter frequency
13	Touch Calibration	Touch Calibration (for UART Touch)
14	Set User Boot Logo	File Format : PNG, JPG, BMP Image Size : 1280 X 720 pixel
15	Upgrade Device	(Hidden menu) Firmware update is available.

DEVICE SETTINGS - FMT Settings

[ANDROID INTERFACE]

ROiK-MIB2

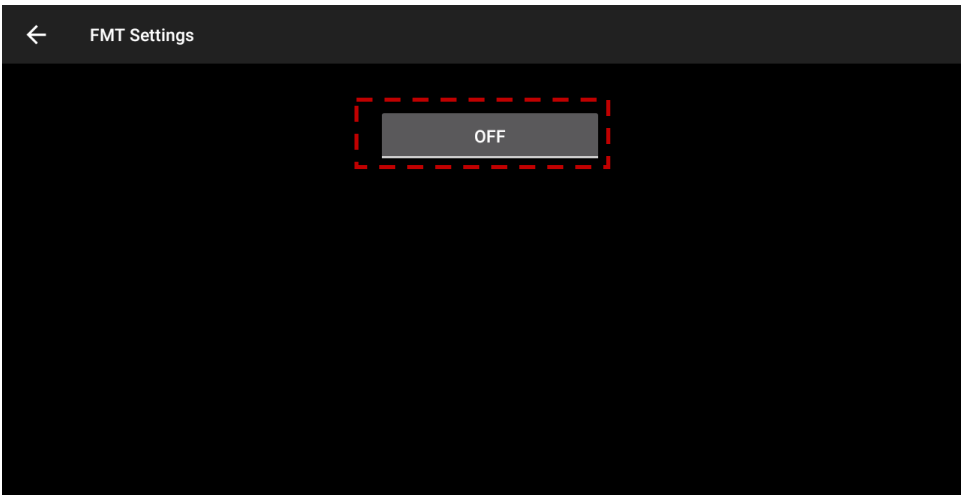
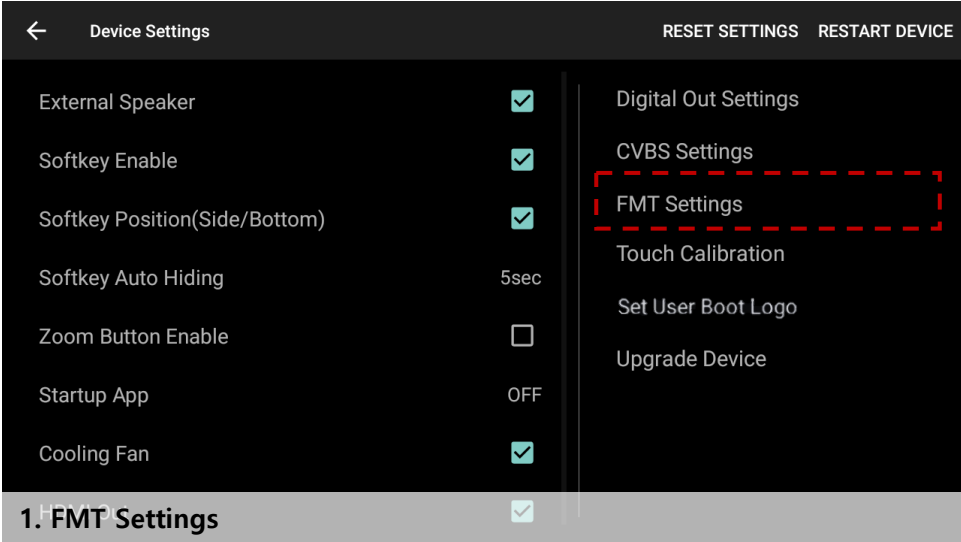

2. Press 'OFF' in the FMT Setting screen.

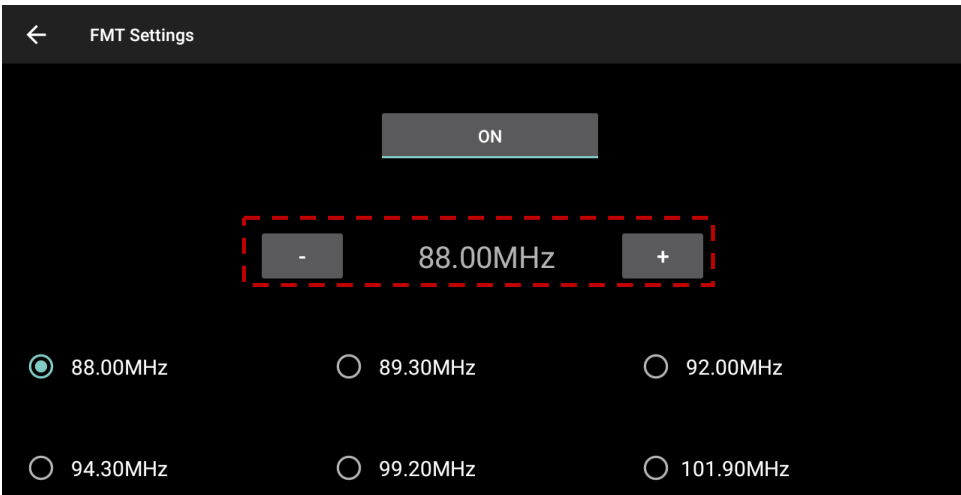

3. Setting

DEVICE SETTINGS – CALIBRATION (RESISTIVE TOUCH)

※ Capacitive touch panel no need set calibration

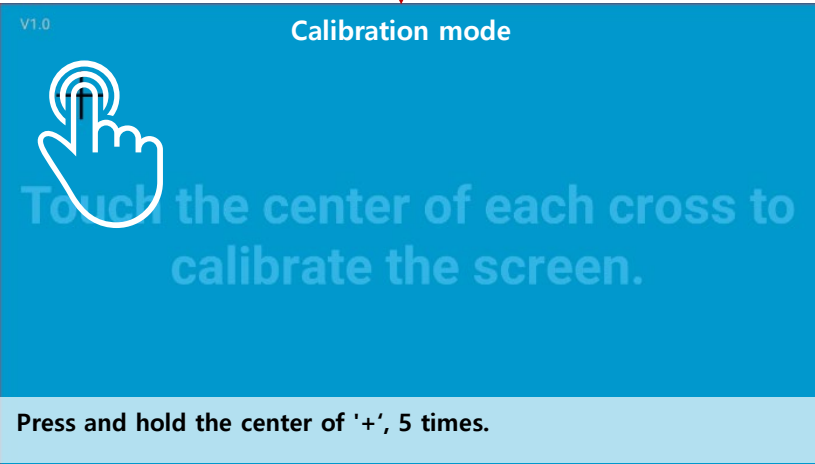
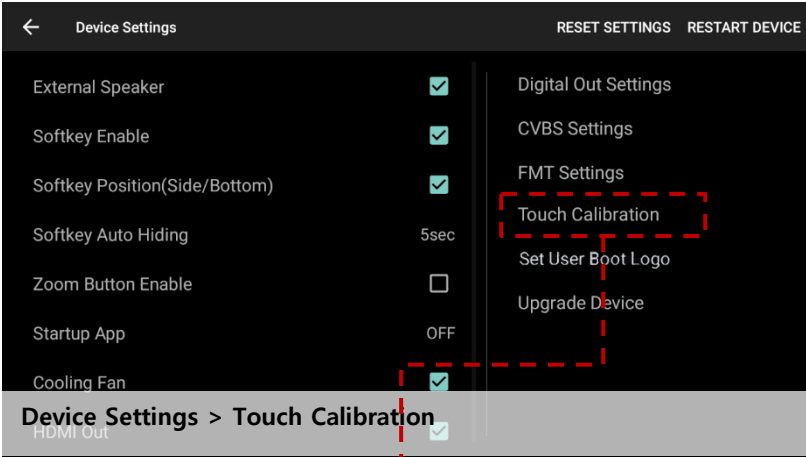

DEVICE SETTINGS - USER LOGO UPDATE

Set User Boot Logo Activate

1. Device Setting
2. Click 'Set Use Boot Logo' and select boot logo image.

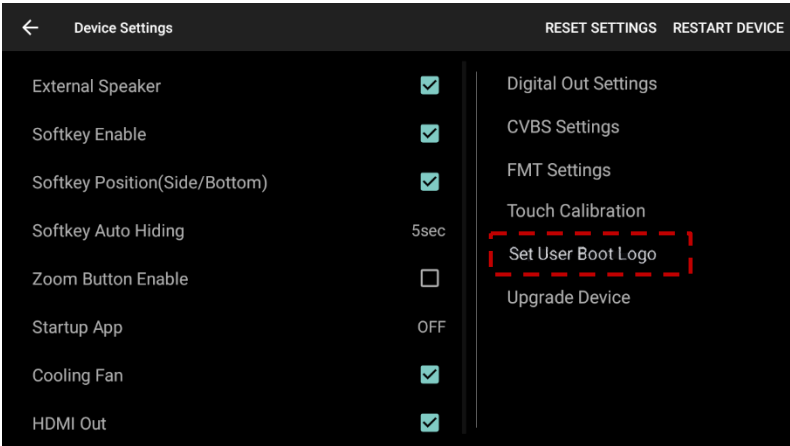

※ File Format : PNG, JPG, BMP
 ※ Image Size : 1280px X 720px

FIRMWARE UPGRADE

A Recommend

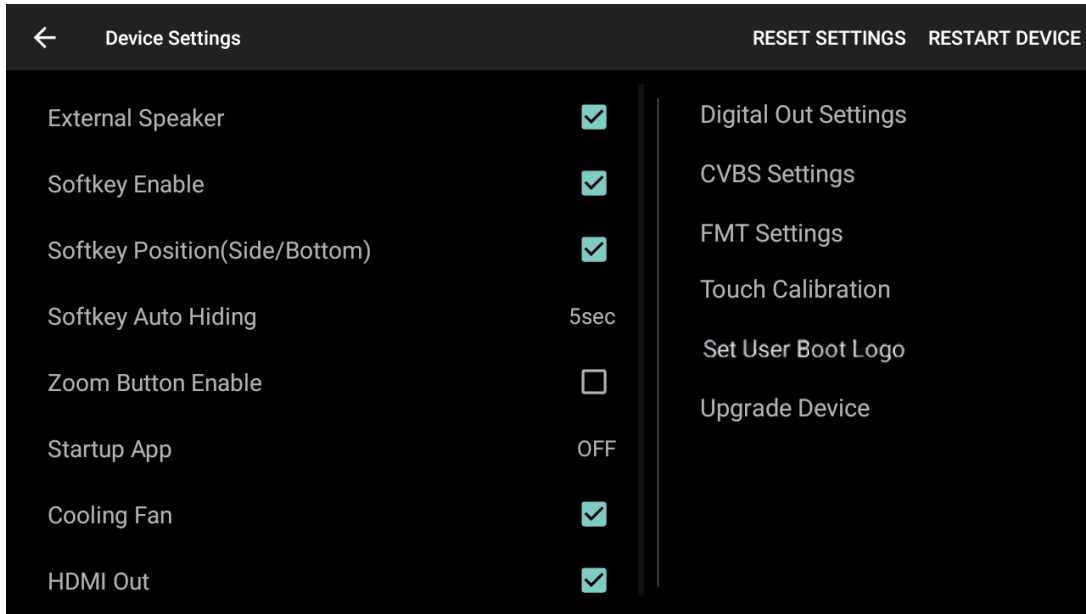

Copy 'system_roik10' folder to USB Memory root and insert to USB1 Port.

Select Upgrade Menu, it will start upgrade

*'/usb disk/system_roik10' Folder have 'update.img' file

* If there is no update file, "Upgrade Device" menu is not show

※ After firmware update, be sure to perform factory reset to apply the firmware.

※ Update Time will 3~4 min, after first time booting take 3~4 min.

※ USB format type = FAT32 / use on USB1 Port only.

B

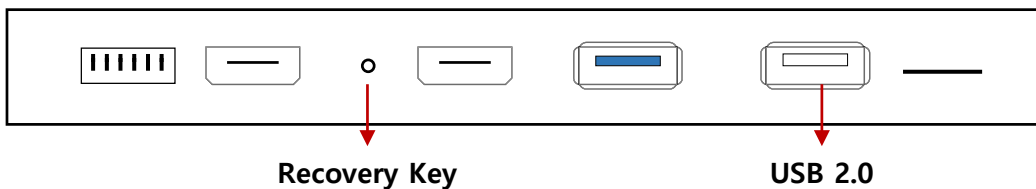

Copy 'system_roik10' folder to USB Memory root and insert to USB1.

Push hold "Recovery Key" and turn on (re-connect power cable), it will start upgrade

*'/usb disk/system_roik10' Folder have 'update.img' file

※ After firmware update, be sure to perform factory reset to apply the firmware.

※ Update Time will 3~4 min, after first time booting take 3~4 min.

※ USB format type = FAT32 / use on USB1 Port only.

FACTORY RESET

A Recommend

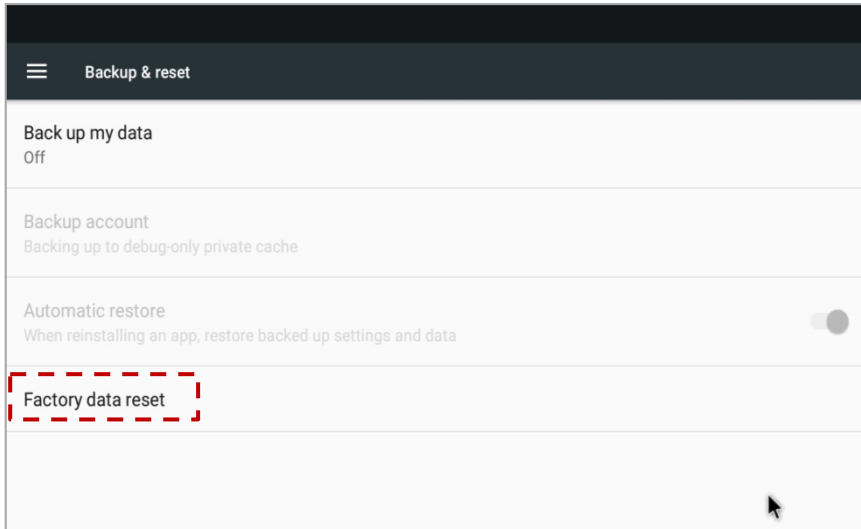

01. Setting

- ▶ Backup & Reset
- ▶ Factory data Reset

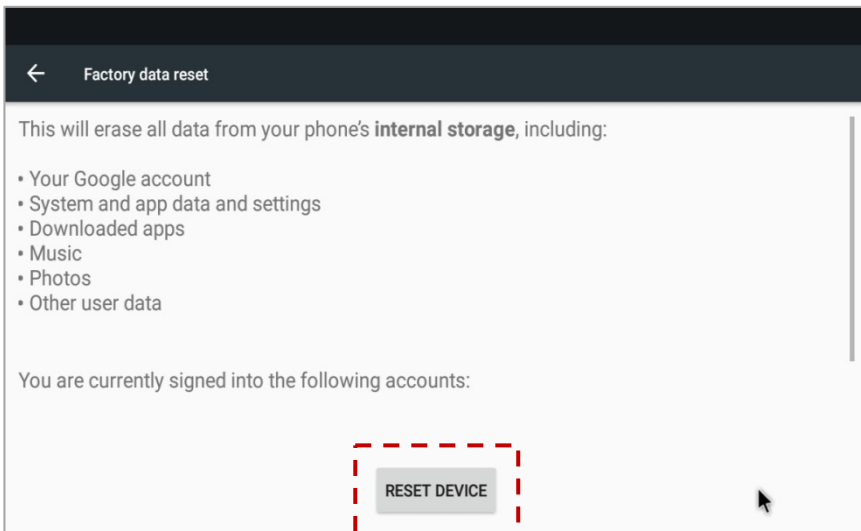

02. Select "RESET DEVICE"

= Factory Reset
Wait until restart unit

※ After reboot system, it takes 3~4 min

INTERFACE SETTING

[ANDROID INTERFACE]

ROiK-MIB2

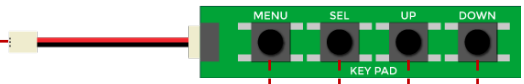
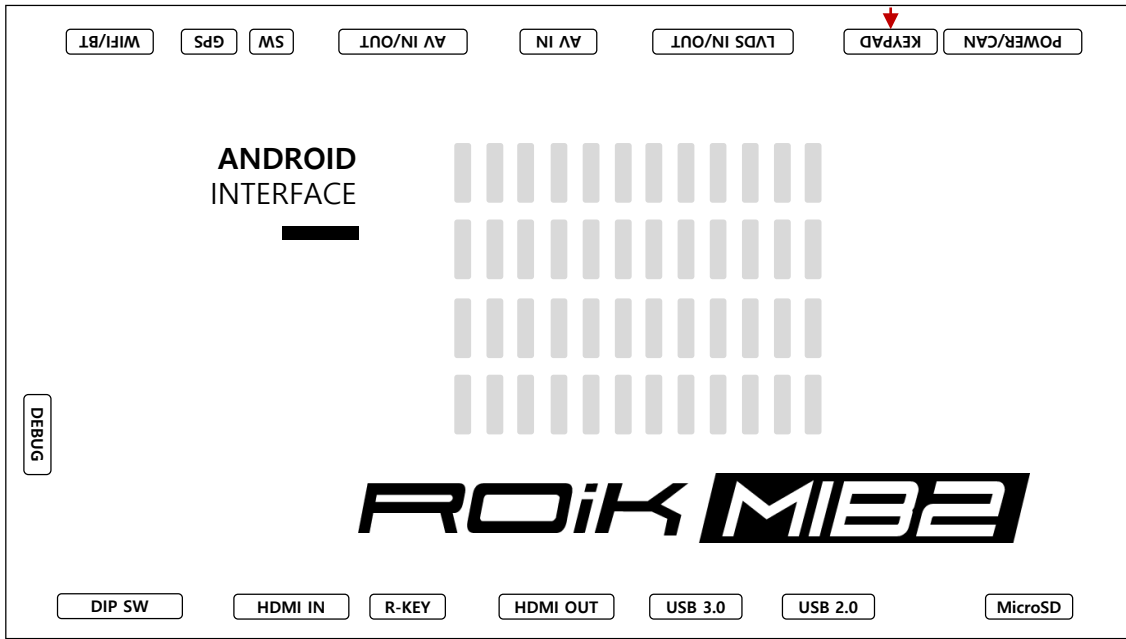

- MENU** Enter the setting menu
- SEL** Select setting menu
- UP** Moving Up
- DOWN** Moving Down

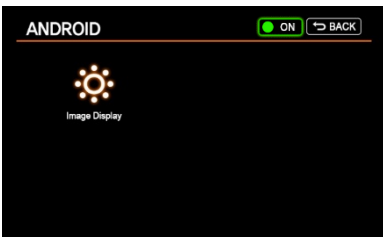
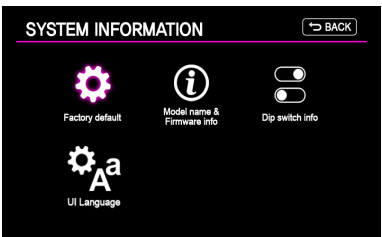
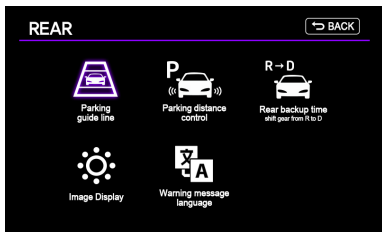
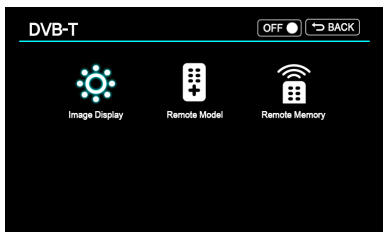
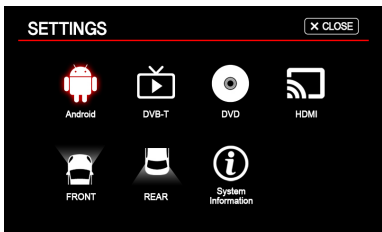

USE PAS-LINE SETTING

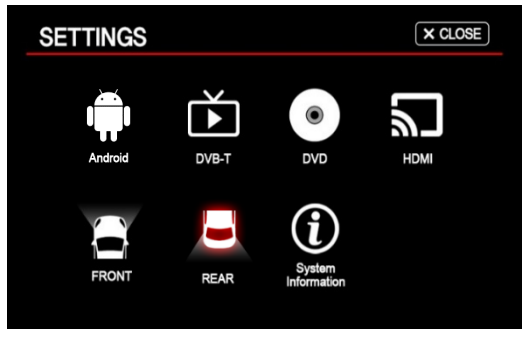

Select "REAR"

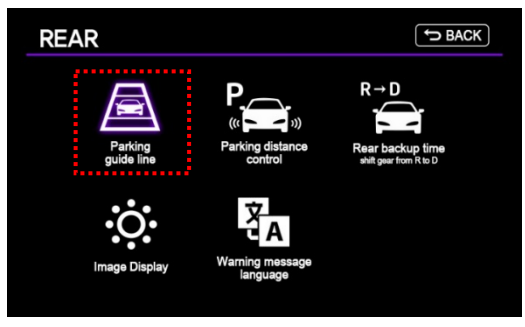

Select "Parking guide line"

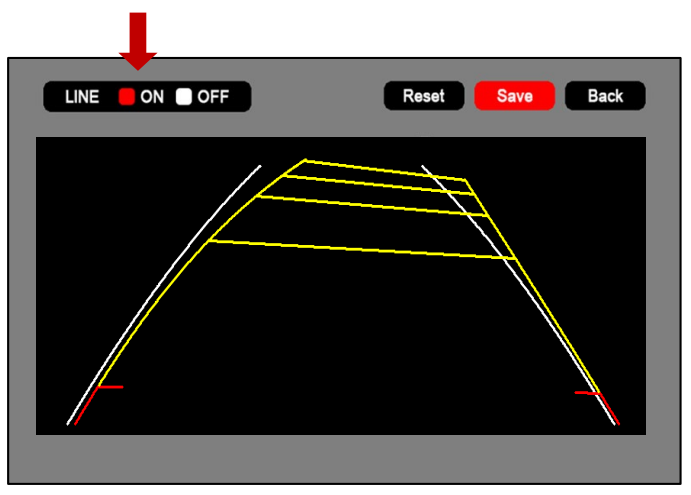

To use pas line, you can use it after selecting line on the setting screen

QUICK INFO

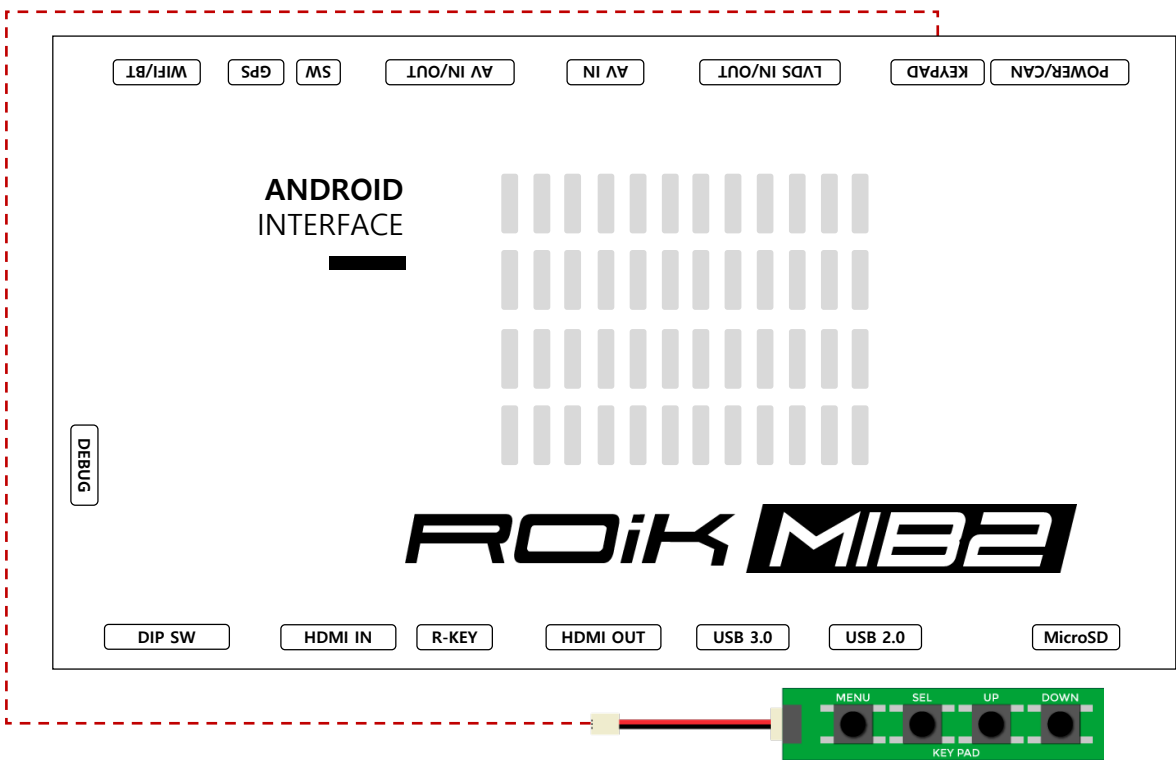

To Enter Quick Info.

1. Press Menu Button to change oem screen to Interface screen.
2. Press down button in the interface screen for 3 seconds.



**A-912 RM Tera-Tower2, 201
Songpa-Daero, Songpa-gu, Seoul, Korea**

T. (+82) 6204-0912

F. (+82) 6204-0913

E. kap@kaptrader.com